

For the benefit and convenience of its customers, Fluke Corporation (Fluke) has reproduced this copy of a manual which is no longer in production. This manual has not been edited or updated since the revision date shown on the *lower left hand corner of the first page*. Fluke will not be liable for any claims, losses or damages of any kind incurred by any user arising from use of this manual.

# **6080A/AN**

**SYNTHESIZED SIGNAL GENERATOR**

# Operator Manual

P/N 857748  
OCTOBER 1989

©1989 John Fluke Mfg. Co., Inc. All rights reserved. Litho U.S.A.

**FLUKE**



CHANGE/ERRATA INFORMATION

ISSUE NO: 1      10/89

This change/errata contains information necessary to ensure the accuracy of the following manual:

**MANUAL**

Title:            6080A/AN Operator  
Print Date:      October 1989  
Rev.- Date:      ---

**C/E PAGE EFFECTIVITY**

Page No.	Print Date
1	9/89
2	9/89

**ERRATA #1**

On page 5A-12, Figure 5A-3, add the following prior to the OPC entry,

Error 84: IEEE 488.2 Query after Indefinite Response

This error occurs when a query which generates a response of type <arbitrary response data> is followed by another query without first reading the response.

On page 5B-3, Table 5B-1, under MISCELLANEOUS, delete:

```
*DDT          Define device trigger buffer
*DDT          Query device trigger buffer
```

Make the following changes to Table 5B-3:

On page 5B-11, under BRT\_FIELD,

```
CHANGE:  Restrictions:  Rejected during manual or single sweep.
TO:      Restrictions:  Rejected during sweep.
```

On page 5B-15, delete \*DDT through the NOTE.

On page 5B-16, delete all the information referring to \*DDT?

On page 5B-35, under STEP\_FIELD,

```
CHANGE:  Restrictions:  Rejected during single sweep.
TO:      Restrictions:  Rejected during manual or single sweep.
```

On page 5D-8, Table 5D-3, delete the following:

```
CT|*DDT|Configure trigger buffer|6070|6060|6062|6080
```

On page C-3/C-4, Appendix C, change the following:

```
FROM:    83   IEEE command not allowed in local mode
TO:      83   IEEE command not allowed in local or listen-only mode
```

Under #83 add:

```
84 IEEE 488.2 query after indefinite response
```

On pages 4B-2 through 4B-7, change the running heads,

```
FROM:    FRONT PANEL OPERATION
         RF FREQUENCY

TO:      FRONT PANEL OPERATION
         RF AMPLITUDE
```



# List of Tables

**TABLE TITLE PAGE**

1-1.	Accessories Included with Each Signal Generator .....	1-3
1-2.	Optional Accessories .....	1-3
1-3.	6080A/AN Specifications .....	1-4
1-4.	Typical Signal Generator Performance .....	1-9
3-1.	Front Panel Display Features .....	3-3
3-2.	Front Panel Keys and Connectors .....	3-6
3-3.	Rear Panel Features .....	3-10
4A-1.	6080A/AN Frequency Bands .....	4A-3
4B-1.	Relative Amplitude Unit Combinations .....	4B-5
4B-2.	RF Amplitude Bands .....	4B-7
4C-1.	FM/ $\phi$ Deviation Limits (FM/ $\phi$ Enabled) .....	4C-5
4C-2.	FM Band Limits .....	4C-7
4C-3.	FM Band Limits - Low Distortion Mode .....	4C-8
4D-1.	Non-Storable/Recallable Parameters .....	4D-1
4D-2.	Non-volatile Memory Locations .....	4D-2
4F-1.	Special Function Codes .....	4F-2
4F-2.	Functions of Edit Knob and Step Keys .....	4F-5
4G-1.	Status Code Descriptions .....	4G-2
5A-1.	Remote/Local State Transitions .....	5A-7
5A-2.	IEEE-488 Interface Function Subsets Supported .....	5A-16
5A-3.	Functional Elements of Commands .....	5A-18
5A-4.	Interface Messages that the 6080A/AN Accepts .....	5A-19
5A-5.	Interface Messages that the 6080A/AN Sends .....	5A-21
5B-1.	Remote Command Summary .....	5B-2
5B-2.	Units Used with Remote Commands .....	5B-6
5B-3.	Remote Commands .....	5B-7
5D-1.	6060 Compatibility Language Codes and Special Functions .....	5D-4
5D-2.	6070 Compatibility Language Codes and Special Functions .....	5D-6
5D-3.	Compatibility Language Commands .....	5D-8
5D-4.	Compatibility Language Units .....	5D-11

SECTION	TITLE	PAGE
<b>4D</b>	<b>MEMORY</b> .....	<b>4D-1</b>
	4D-1. ORGANIZATION OF 6080A/AN MEMORY .....	4D-1
	4D-2. STORE AND RECALL ENTRY .....	4D-3
	4D-3. MEMORY SEQUENCE ENTRY .....	4D-4
	4D-4. MEMORY SEQUENCE DIVIDERS .....	4D-4
	4D-5. MEMORY LOCATION LOCK .....	4D-6
	4D-6. RESET MEMORY TO DEFAULT MEMORY LOCATION .....	4D-6
	4D-7. SINGLE PARAMETER STORE AND RECALL .....	4D-6
<b>4E</b>	<b>SWEEP</b> .....	<b>4E-1</b>
	4E-1. GENERAL DESCRIPTION .....	4E-1
	4E-2. SELECTING THE DIGITAL SWEEP FIELD .....	4E-2
	4E-3. DIGITAL SWEEP MODES .....	4E-2
	4E-4. DIGITAL SWEEP SYMMETRY .....	4E-3
	4E-5. DIGITAL SWEEP DWELL TIME .....	4E-3
	4E-6. DIGITAL FREQUENCY SWEEP .....	4E-4
	4E-7. Frequency Sweep Width Entry .....	4E-5
	4E-8. Frequency Sweep Increment Entry .....	4E-5
	4E-9. Digital Frequency Sweep Example .....	4E-6
	4E-10. DIGITAL AMPLITUDE SWEEP .....	4E-6
	4E-11. Amplitude Sweep Width .....	4E-8
	4E-12. Amplitude Sweep Increment Entry .....	4E-8
	4E-13. Example Digital Amplitude Sweep .....	4E-9
	4E-14. CALIBRATION OF RECORDER/OSCILLOSCOPE .....	4E-10
	4E-15. ANALOG FREQUENCY SWEEP .....	4E-10
<b>4F</b>	<b>SPECIAL FUNCTIONS</b> .....	<b>4F-1</b>
	4F-1. GENERAL DESCRIPTION .....	4F-1
	4F-2. SPECIAL FUNCTION ENTRY .....	4F-3
	4F-3. VIEWING ENABLED SPECIAL FUNCTIONS .....	4F-3
	4F-4. THE SPCL ANNUNCIATOR .....	4F-3
	4F-5. MISCELLANEOUS SPECIAL FUNCTIONS .....	4F-3
	4F-6. Clear Special Functions .....	4F-3
	4F-7. Restore Instrument Preset State .....	4F-4
	4F-8. Execute Self-Test and Display Self-Test Results .....	4F-4
	4F-9. Display Loaded Options .....	4F-4
	4F-10. Display Instrument ID and Software Revision Level .....	4F-4
	4F-11. Blank Front Panel Display .....	4F-4
	4F-12. Select Repeat Rate for Step Keys .....	4F-4
	4F-13. Configure Edit Knob and Step Keys .....	4F-4
<b>4G</b>	<b>ERROR AND STATUS REPORTING</b> .....	<b>4G-1</b>
	4G-1. GENERAL DESCRIPTION .....	4G-1
	4G-2. THE STATUS KEY .....	4G-1
	4G-3. SELF-TEST AND CALIBRATION/COMPENSATION DATA STATUS .....	4G-2

TABLE OF CONTENTS, *continued*

SECTION	TITLE	PAGE
<b>5</b>	<b>REMOTE OPERATION</b> .....	<b>5-1</b>
5-1.	INTRODUCTION .....	5-1
5-2.	SETTING UP THE IEEE-488 INTERFACE .....	5-1
5-3.	Address Setup Procedure .....	5-1
5-4.	Talker/Listener Mode Selection Procedure .....	5-2
5-5.	Compatibility Language Selection Procedure .....	5-2
<b>5A</b>	<b>REMOTE PROGRAMMING</b> .....	<b>5A-1</b>
5A-1.	INTRODUCTION .....	5A-1
5A-2.	COMMAND SYNTAX INFORMATION .....	5A-2
5A-3.	Parameter Syntax Rules .....	5A-2
5A-4.	Extra Space Characters .....	5A-3
5A-5.	Terminators .....	5A-3
5A-6.	Incoming Character Processing .....	5A-3
5A-7.	Response Message Syntax .....	5A-4
5A-8.	INPUT BUFFER OPERATION .....	5A-4
5A-9.	COMMANDS .....	5A-4
5A-10.	Multiple Commands .....	5A-4
5A-11.	Command Processing .....	5A-4
5A-12.	Command Restrictions .....	5A-5
5A-13.	Commands That Require the CAL COMP Switch Set .....	5A-5
5A-14.	REMOTE/LOCAL STATE TRANSITIONS .....	5A-5
5A-15.	CHECKING THE INSTRUMENT STATUS .....	5A-7
5A-16.	Serial Poll Status Byte (STB) .....	5A-7
5A-17.	BIT ASSIGNMENTS FOR THE STB AND SRE .....	5A-7
5A-18.	SERVICE REQUEST LINE (SRQ) .....	5A-9
5A-19.	SERVICE REQUEST ENABLE REGISTER (SRE) .....	5A-9
5A-20.	PROGRAMMING THE STB AND SRE .....	5A-10
5A-21.	Event Status Register (ESR) .....	5A-10
5A-22.	BIT ASSIGNMENTS FOR THE ESR AND ESE .....	5A-10
5A-23.	EVENT STATUS ENABLE REGISTER (ESE) .....	5A-12
5A-24.	PROGRAMMING THE ESR AND ESE .....	5A-12
5A-25.	Output Queue .....	5A-13
5A-26.	Error Queue .....	5A-13
5A-27.	Instrument Status Register .....	5A-14
5A-28.	BIT ASSIGNMENTS FOR THE ISR, ISCR, AND ISCE .....	5A-14
5A-29.	INSTRUMENT STATUS CHANGE REGISTER (ISCR) .....	5A-14
5A-30.	INSTRUMENT STATUS CHANGE ENABLE REGISTER (ISCE) .....	5A-15
5A-31.	PROGRAMMING THE ISR, ISCR, AND ISCE .....	5A-15
5A-32.	Status Queue .....	5A-16
5A-33.	IEEE-488 INTERFACE CONFIGURATION .....	5A-16
5A-34.	BUS COMMUNICATION OVERVIEW .....	5A-16
5A-35.	Definition: Queries and Commands .....	5A-17
5A-36.	Functional Elements of Commands .....	5A-17
5A-37.	Interface Messages .....	5A-19
5A-38.	THE IEEE-488 CONNECTOR .....	5A-21
5A-39.	REMOTE PROGRAM EXAMPLES .....	5A-22
5A-40.	Using the *OPC?, *OPC, and *WAI Commands .....	5A-22
5A-41.	Using the *DDT and *TRG Commands .....	5A-23



On page 4B-2, paragraph 4B-4,

CHANGE: ALTERNATE AMPLITUDE UNITS:

$$\begin{aligned} \text{dBmV} &= \text{dBm} + 47.0 \\ \text{dB V} &= \text{dBm} + 107.0 \\ \text{dBf} &= \text{dBm} + 120.0 \end{aligned}$$

TO: ALTERNATE AMPLITUDE UNITS:

$$\begin{aligned} \text{dBmV} &= \text{dBm} + 47.0 \text{ dB} \\ \text{dBuV} &= \text{dBm} + 107.0 \text{ dB} \\ \text{dBf} &= \text{dBm} + 120.0 \text{ dB} \end{aligned}$$

On page 4B-3, paragraph 4B-5,

CHANGE: EMF UNITS CONVERSION:

$$\begin{aligned} \text{EMF dBmV} &= \text{dBmV} + 6 \text{ dBmV} \\ \text{EMF dBuV} &= \text{dB V} + 6 \text{ dB V} \\ \text{EMF V} &= 2 * \text{V} \end{aligned}$$

TO: EMF UNITS CONVERSION:

$$\begin{aligned} \text{EMF dBmV} &= \text{dBmV} + 6 \text{ dBmV} \\ \text{EMF dBuV} &= \text{dBuV} + 6 \text{ dBuV} \\ \text{EMF V} &= 2 * \text{V} \end{aligned}$$

On page 4F-2, Table 4F-1, under MISCELLANEOUS,

CHANGE: Display option loading status|08|\*IDN?  
TO: Display option loading status|08|\*OPT?



# Table of Contents

SECTION	TITLE	PAGE
<b>1</b>	<b>INTRODUCTION AND SPECIFICATIONS</b> .....	<b>1-1</b>
1-1.	INTRODUCTION .....	1-1
1-2.	UNPACKING THE SIGNAL GENERATOR .....	1-1
1-3.	SAFETY .....	1-2
1-4.	ACCESSORIES .....	1-3
1-5.	SIGNAL GENERATOR SPECIFICATIONS .....	1-3
<b>2</b>	<b>INSTALLATION</b> .....	<b>2-1</b>
2-1.	INTRODUCTION .....	2-1
2-2.	INITIAL INSPECTION .....	2-1
2-3.	SERVICE INFORMATION .....	2-1
2-4.	Warranty .....	2-1
2-5.	Service .....	2-1
2-6.	SETTING UP THE 6080A/AN .....	2-2
2-7.	Power Requirements .....	2-2
2-8.	Line Voltage Selection and Fuse Replacement .....	2-2
2-9.	Rack or Bench Mounting the 6080A/AN .....	2-3
2-10.	Frequency Reference .....	2-3
2-11.	Local and Remote Operation .....	2-3
2-12.	Power-On Sequence .....	2-3
<b>3</b>	<b>SIGNAL GENERATOR FEATURES</b> .....	<b>3-1</b>
3-1.	GENERAL INFORMATION .....	3-1
3-2.	FRONT PANEL FEATURES .....	3-1
3-3.	Display Features .....	3-1
3-4.	Front Panel Keys and Connectors .....	3-1
3-5.	REAR PANEL FEATURES .....	3-1
<b>4</b>	<b>FRONT PANEL OPERATION</b> .....	<b>4-1</b>
4-1.	INTRODUCTION .....	4-1
4-2.	PARAMETER ENTRY AND MODIFICATION .....	4-1
4-3.	Parameter Entry .....	4-1
4-4.	Bright-Digit Edit .....	4-2
4-5.	Step Increment and Decrement .....	4-3

TABLE OF CONTENTS, *continued*

SECTION	TITLE	PAGE
<b>4A</b>	<b>RF FREQUENCY</b> .....	<b>4A-1</b>
4A-1.	INTRODUCTION .....	4A-1
4A-2.	RF FREQUENCY ENTRY .....	4A-1
4A-3.	RF FREQUENCY STEP ENTRY .....	4A-1
4A-4.	RF FREQUENCY RELATIVE MODE .....	4A-2
4A-5.	EXTERNAL FREQUENCY REFERENCE .....	4A-3
4A-6.	RF FREQUENCY BANDS .....	4A-3
<b>4B</b>	<b>RF AMPLITUDE</b> .....	<b>4B-1</b>
4B-1.	INTRODUCTION .....	4B-1
4B-2.	RF AMPLITUDE ENTRY .....	4B-1
4B-3.	RF AMPLITUDE UNITS CONVERSION .....	4B-2
4B-4.	ALTERNATE DB REFERENCE UNITS SELECTION .....	4B-2
4B-5.	UNTERMINATED OUTPUT (EMF) MODE .....	4B-3
4B-6.	RF AMPLITUDE STEP ENTRY .....	4B-4
4B-7.	RF AMPLITUDE RELATIVE MODE .....	4B-4
4B-8.	RF OUTPUT ON/OFF .....	4B-6
4B-9.	RF AMPLITUDE BANDS .....	4B-6
4B-10.	RF AMPLITUDE FIXED-RANGE MODE .....	4B-7
4B-11.	ALTERNATE OUTPUT COMPENSATION MODES .....	4B-8
4B-12.	SELECTING ALTERNATE OUTPUT COMPENSATION DATA ...	4B-8
<b>4C</b>	<b>MODULATION</b> .....	<b>4C-1</b>
4C-1.	INTRODUCTION .....	4C-1
4C-2.	MODULATION, AM .....	4C-1
4C-3.	AM Depth and AM Depth Step Size Entry .....	4C-2
4C-4.	Internal AM .....	4C-3
4C-5.	External AM .....	4C-3
4C-6.	External AM, DC Coupled .....	4C-3
4C-7.	MODULATION, FM/ $\phi$ .....	4C-3
4C-8.	FM/ $\phi$ Deviation and FM/ $\phi$ Step Size Entry .....	4C-4
4C-9.	FM/ $\phi$ Units Conversion .....	4C-5
4C-10.	Internal FM/ $\phi$ .....	4C-6
4C-11.	External FM/ $\phi$ .....	4C-6
4C-12.	External DCFM .....	4C-6
4C-13.	FM Bands .....	4C-7
4C-14.	Low Distortion/Fixed-Range FM .....	4C-8
4C-15.	Low Rate FM .....	4C-9
4C-16.	High Rate $\phi$ .....	4C-9
4C-17.	MODULATION, PULSE .....	4C-10
4C-18.	External Pulse .....	4C-10
4C-19.	Internal Pulse .....	4C-10
4C-20.	INTERNAL MODULATION OSCILLATOR .....	4C-10
4C-21.	Modulation Frequency Entry and Step Size Entry .....	4C-10
4C-22.	Extended Resolution Modulation Frequency Entry .....	4C-12
4C-23.	Modulation Level Entry and Step Size Entry .....	4C-12
4C-24.	Modulation Output On/Off .....	4C-14
4C-25.	Internal Modulation Waveform Selection .....	4C-14
4C-26.	Internal Pulse Generator Mode .....	4C-15
4C-27.	Pulse Width Selection .....	4C-16

SECTION	TITLE	PAGE
<b>5B</b>	<b>REMOTE COMMAND TABLE .....</b>	<b>5B-1</b>
	5B-1. REMOTE COMMAND SUMMARY .....	5B-1
	5B-2. REMOTE COMMANDS .....	5B-1
<b>5C</b>	<b>TALK-ONLY/LISTEN-ONLY OPERATION .....</b>	<b>5C-1</b>
	5C-1. INTRODUCTION .....	5C-1
	5C-2. TALK-ONLY OPERATION .....	5C-1
	5C-3. LISTEN-ONLY OPERATION .....	5C-2
	5C-4. LISTEN-ONLY/TALK-ONLY EXAMPLE .....	5C-2
<b>5D</b>	<b>COMPATIBILITY LANGUAGES .....</b>	<b>5D-1</b>
	5D-1. INTRODUCTION .....	5D-1
	5D-2. PROGRAMMING THE LANGUAGE .....	5D-1
	5D-3. Incompatibilities .....	5D-1
	5D-4. Converting 6060 and 6070 Programs to Use the 6080 Language ....	5D-2
 <b>APPENDICES</b>		
<b>A</b>	INSTRUMENT PRESET STATE .....	A-1
<b>B</b>	SPECIAL FUNCTION TABLE .....	B-1
<b>C</b>	REJECTED ENTRY ERROR CODES .....	C-1
<b>D</b>	OVERRANGE/UNCAL STATUS CODES .....	D-1
<b>E</b>	SELF-TEST STATUS CODES .....	E-1
<b>F</b>	REAR PANEL AUX CONNECTOR PINOUT .....	F-1



# List of Illustrations

<b>FIGURES</b>	<b>TITLE</b>	<b>PAGE</b>
2-1.	Fuse/Line Voltage Selection Assembly .....	2-2
2-2.	6080A/AN Outside Dimensions .....	2-4
3-1.	Front Panel Features .....	3-2
3-2.	Rear Panel Features .....	3-11
5A-1.	Overview of Status Data Structure .....	5A-8
5A-2.	Bit Assignments for the STB and SRE .....	5A-9
5A-3.	Bit Assignments for ESR and ESE .....	5A-11
5A-4.	Bit Assignments for the ISR, ISCR, and ISCE .....	5A-14
5A-5.	IEEE-488 Connector and Pin Assignments .....	5A-21





# Section 1

## Introduction and Specifications

### INTRODUCTION

1-1.

The 6080A/AN Synthesized RF Signal Generator (also referred to as the “signal generator”) is a fully programmable, precision, synthesized signal generator. The 6080A/AN is designed for applications that require good modulation, frequency accuracy, and output level performance with excellent spectral purity. The signal generator is well suited for testing a wide variety of RF components and systems including filters, amplifiers, mixers, and radios, particularly off-channel radio testing.

Specifications of the 6080A/AN are provided at the end of this section. The salient features of the 6080A/AN are as follows:

- RF frequency range of 0.5 MHz to 1024 MHz in 1 Hz steps
- RF level range of +13 to -137 dBm in 0.1 dB steps
- Internal and External Modulation: AM, FM, and Pulse
- Internal 10 Hz to 100 kHz Synthesized Sine Wave Modulation Oscillator
- Fifty Storable and Recallable Memory Locations
- Standard IEEE-488 (GPIB) Interface, complying with ANSI/IEEE Standards 488.1-1987 and 488.2-1987
- Closed-case calibration capabilities for Frequency Reference, AM, FM, and Level.

### UNPACKING THE SIGNAL GENERATOR

1-2.

The shipping container should include a 6080A/AN Synthesized RF Signal generator, an Operator Manual, a Service Manual, a line power cord and two BNC dust caps. Accessories ordered for the signal generator are shipped in a separate container.

Section 2, “Installation”, gives instructions on inspecting the new signal generator and explains what to do if it arrives damaged. Reshipment information is also included.

**SAFETY**

**1-3.**

This manual contains information, warnings, and cautions that should be followed to ensure safe operation and to maintain the generator in a safe condition.

The signal generator is designed primarily for indoor use and may be operated in temperatures from 0 to 50°C without degradation of its safety.

**WARNING**

**TO AVOID ELECTRIC SHOCK, USE A POWER CORD THAT HAS A THREE-PRONG PLUG. IF THE PROPER POWER CORD IS NOT USED, THE 6080A/AN CASE CAN DEVELOP AN ELECTRICAL POTENTIAL ABOVE EARTH GROUND.**

**WARNING**



**PIVOTING MODULE INSTRUCTIONS**

**IF NECESSARY DURING REPAIRS, PIVOT THE TOP (SYNTHESIZER) MODULE UP TO ALLOW ACCESS TO ALL PARTS OF THE SIGNAL GENERATOR. THE MODULE IS HEAVY AND CARE SHOULD BE EXERCISED. THE GAS STRUT IS PROVIDED FOR PROTECTION. CHECK THE CORRECT OPERATION OF THE GAS STRUT BY NOTING THE RESISTANCE TO RAPID CLOSING OF THE MODULE WHILE YOU FIRMLY GRASP THE MODULE BY THE HANDLE.**

**OPENING AND CLOSING INSTRUCTIONS ARE GIVEN BELOW AND ARE REPEATED ON THE DECAL ON THE TOP FRONT OF THE SYNTHESIZER MODULE.**

**RAISING THE MODULE:**

- 1. REMOVE THREE HOLD-DOWN SCREWS LOCATED ON THE SIDE RAILS.**
- 2. GRASP THE HANDLE AND LIFT UP.**
- 3. LOCK IN THE UP POSITION BY INSTALLING ONE SCREW IN THE PROTRUDING BOSS ON EACH SIDE RAIL.**

**LOWERING THE MODULE:**

- 1. SUPPORT IN THE UP POSITION AND REMOVE TWO LOCK UP SCREWS.**
- 2. GRASP THE HANDLE AND LOWER THE MODULE KEEPING YOUR HANDS CLEAR.**
- 3. LOCK IN THE DOWN POSITION BY REINSTALLING THE THREE HOLD-DOWN SCREWS.**

**ACCESSORIES**

**1-4.**

The accessories and manuals included with each signal generator are listed in Table 1-1.

The optional accessories available are listed in Table 1-2.

**SIGNAL GENERATOR SPECIFICATIONS**

**1-5.**

Table 1-3 lists the 6080A/AN specifications. Table 1-4 lists typical performance characteristics.

**Table 1-1. Accessories Included with each Signal Generator**

DESCRIPTION	PART NUMBER	QUANTITY
Operator Manual	857748	1
Service Manual	868906	1
Line Power Cord	284174	1
BNC Dust Cap	478982	2

**Table 1-2. Optional Accessories**

DESCRIPTION	ACCESSORY NO.
Rack Mount Kit Includes M05-205-600 (5 1/4-inch Rack Mount Ears) and M00-280-610 (24-inch Rack Slides)	Y6001
IEEE-488 Shielded Cable, 1 meter	Y8021
IEEE-488 Shielded Cable, 2 meters	Y8022
IEEE-488 Shielded Cable, 4 meters	Y8023
Coaxial Cable, 50 ohms, 3 feet, BNC (m) both ends	Y9111
Coaxial Cable, 50 ohms, 6 feet, BNC (m) both ends	Y9112

# INTRODUCTION AND SPECIFICATIONS

Table 1-3. 6080A/AN Specifications

<i>NOTE</i>	
<i>Unless otherwise noted, the following performance is guaranteed over the specified environmental and AC power line conditions two hours after turn-on.</i>	
<b>FREQUENCY (10-DIGIT DISPLAY)</b>	
RANGE .....	0.50 to 1024 MHz in 7 bands:
BAND .50-15 MHz .....	0.50 to 14.999999 MHz,
BAND 15-32 MHz .....	15 to 31.999999 MHz,
BAND 32-64 MHz .....	32 to 63.999999 MHz,
BAND 64-128 MHz .....	64 to 127.999999 MHz,
BAND 128-256 MHz .....	128 to 255.999999 MHz,
BAND 256-512 MHz .....	256 to 511.999999 MHz,
BAND 512-1024 MHz .....	512 to 1024 MHz.
RESOLUTION .....	1 Hz
ACCURACY .....	Same as reference (See REFERENCE).
REFERENCE (Internal) .....	The unit operates on an internal 10 MHz Temperature Compensated Crystal Oscillator (TCXO). The frequency variation will be < 10 ppm peak to peak over the temperature range of 0 to +50°C.  Internal reference signal (10 MHz) available at rear panel REF OUT connector, level > 0 dBm, terminated into 50 ohms.  Frequency stability after 2 hour warmup is < ± 0.05 ppm/hour at +25°C ± 5°C.
REFERENCE (External) .....	Accepts 5 or 10 MHz signal. Level required is 0.5 to 2.0V RMS into 50 ohms termination.
<b>AMPLITUDE (3 1/2-DIGIT DISPLAY)</b>	
RANGE .....	+13 to -137 dBm
RESOLUTION .....	0.1 dB (< 1% or 1 nV in Volts). Annunciators for dB, dBm, V, mV, μV, dB mV, dB μV, dBf, and EMF.
ACCURACY .....	± 1.5 dB from +13 to -117 dBm ± 3 dB from -117 to -137 dBm
SOURCE VSWR .....	< 1.5:1 for levels below -10 dBm, < 2.5:1 elsewhere.
FLATNESS .....	± 1.0 dB @ +10 dBm.

Table 1-3. 6080A/AN Specifications (cont)

<b>SPECTRAL PURITY (CW ONLY)</b>	
NON-HARMONIC SPURIOUS .....	< -100 dBc for offsets greater than 15 kHz.
<i>NOTE</i>	
<i>Fixed frequency spurs are &lt; -100 dBc or &lt; -140 dBm, whichever is larger.</i>	
<i>NOTE</i>	
<i>dBc refers to decibels relative to the carrier frequency, or in this case, relative to the signal level.</i>	
HARMONICS / SUBHARMONICS .....	< -30 dBc for levels < +7 dBm.
POWER LINE SPURIOUS .....	< -40 dBc within ± 15 kHz of carrier.
RESIDUAL FM (RMS in 0.05- to 15-kHz band) .....	< 20 Hz
SSB PHASE NOISE .....	< -130 dBc/Hz @ 20 kHz offset for Frequency < 512 MHz
	< -124 dBc/Hz @ 20 kHz offset for Frequency > 512 MHz
RESIDUAL AM (in 0.05- to 15-kHz Band)	< -80 dBc. (.01%)
<b>AMPLITUDE MODULATION (3-DIGIT DISPLAY)</b>	
(Amplitude < 0 dBm)	
INDICATED DEPTH RANGE .....	0 to 99.9%.
RESOLUTION .....	0.1%.
ACCURACY (0 to 90%) .....	± 7% AM at 1 kHz rate
DISTORTION .....	< 5% Total Harmonic Distortion (THD) @ 50% AM (rates = 0.1, 1, 10 kHz)
BANDWIDTH (3 dB) .....	10 Hz to 100 kHz
INCIDENTAL FM .....	< 200 Hz at 1 kHz rate, 50% AM.
<b>FREQUENCY MODULATION (3-DIGIT DISPLAY)</b>	
DEVIATION RANGES .....	0 to 999 Hz
	1 to 9.99 kHz
	10 to 99.9 kHz
	100 to 999 kHz
	1 to 4 MHz
EXT RATES .....	DC to 100 kHz

# INTRODUCTION AND SPECIFICATIONS

**Table 1-3. 6080A/AN Specifications (cont)**

DEVIATION..... (rates = .1, 1, 50 kHz)	DEV	RF Frequency
	0 to 1 kHz min	Frequency < 1 MHz
	0 to 10 kHz min	1 MHz < Frequency < 32 MHz
	0 to 100 kHz min	32 MHz < Frequency < 128 MHz
	0 to 1 MHz min	Frequency > 128 MHz
RESOLUTION .....	3 digits.	
ACCURACY..... (measured vs. indicated deviation, 1 kHz rate)	± (5% + 10 Hz)	
DISTORTION..... (does not include effects of residual FM)	< 5% THD for rates of 0.1, 1, and 50 kHz	
	< 2% THD for deviation < 20 kHz and 1 kHz rate	
INCIDENTAL AM .....	< 1% AM at 1-kHz rate, for peak deviation < 100 kHz	
<b>PULSE MODULATION (RF Frequencies from 10 to 1024 MHz)</b>		
ON/OFF RATIO .....	35 dB minimum	
RISE & FALL TIMES.....	< 1 μs	
PULSE WIDTH .....	Minimum at least 5 μs	
REP RATE .....	Minimum at least 50 Hz to 50 kHz	
EXTERNAL PULSE MODULATION .....	The pulse input is TTL compatible and 50 ohm terminated with an internal active pull-up. It can be modeled as 1.2V in series with 50 ohms at the pulse modulation input connector. The signal generator senses input terminal voltage and turns the RF off when the terminal voltage drops below 1 ± 0.1V. Max allowable applied voltage, ± 10V.	
NON-VOLATILE MEMORY .....	50 instrument states are retained for typically 2 years, even with the power mains disconnected.	
<b>REVERSE POWER PROTECTION</b>		
PROTECTION LEVEL .....	Up to 50 watts from a 50 ohm source. Up to 50V DC. Signal generator output is AC coupled. Protection is provided when the signal generator is off.	
TRIP/RESET.....	Flashing RF OFF annunciator indicates a tripped condition. Pushing RF ON/OFF button will reset signal generator.	

Table 1-3. 6080A/AN Specifications (cont)

<b>IEEE-488</b>	
INTERFACE FUNCTIONS .....	SH1, AH1, T5, TE0, L3, LE0, SR1, RL1, PP0, DC1, DT1, C0, and E2. Complies with IEEE Std. 488.1-1987 and 488.2-1987.
<b>INTERNAL MODULATION SOURCE</b>	
SINE WAVE .....	10 Hz to 100 kHz synthesized sine wave.
DISPLAY RANGES .....	00.1 to 99.9 Hz 100 to 999 Hz 1.00 to 9.99 kHz 10.0 to 99.9 kHz 100 to 200 kHz
FREQUENCY RESOLUTION .....	0.1 Hz or 3 digits
OUTPUT LEVEL RANGE .....	0 to 1V RMS into 600 ohms
DISTORTION .....	< 2% THD
OUTPUT IMPEDANCE .....	600 ohms ±10%
<b>EXTERNAL MODULATION</b>	
1V peak provides indicated modulation index. Nominal input impedance is 600 ohms. Maximum input level is ± 5 V peak.	
<b>MODULATION MODES</b>	
Any combination of AM, PULSE, and FM, internal or external, may be used.	
<b>GENERAL</b>	
<b>TEMPERATURE</b>	
Operating .....	0 to +50°C (+32 to +122°F).
Non-Operating .....	-40 to +75°C (-40 to +167°F).
<b>HUMIDITY RANGE</b>	
Operating .....	95% to +30°C, 75% to +40°C, and 45% to +50°C.
<b>ALTITUDE</b>	
Operating .....	Up to 10,000 ft.
<b>VIBRATION</b>	
Non-Operating .....	5 to 15 Hz at 0.06 inch, 15 to 25 Hz at 0.04 inch, and 25 to 55 Hz at 0.02 inch, double amplitude (DA).
<b>SHOCK</b>	
Non-Operating .....	MIL T 28800D Class 5, Style E.

**INTRODUCTION AND SPECIFICATIONS**

**Table 1-3. 6080A/AN Specifications (cont)**

<b>ELECTROMAGNETIC COMPATIBILITY..</b>			
	The radiated emissions induce < 1 $\mu$ V into a 1-inch diameter, 2-turn loop, 1-inch from any surface as measured into a 50-ohm receiver.		
<b>COMPLIES WITH THE FOLLOWING STANDARDS:</b>			
	CE03 of MIL-STD-461B (Power and interconnecting leads), 0.015 to 50 MHz.		
	RE02 of MIL-STD-461B (14 kHz to 10 GHz).		
	FCC Part 15 (J), class A.		
	CISPR 11.		
<b>SIZE .....</b>	<b>Width</b>	<b>Height</b>	<b>Depth</b>
	43 cm	13.3 cm	59.7 cm
	17 in	5.25 in	23.5 in
<b>POWER .....</b>	115/230 VAC, $\pm$ 10% 50, 60, and 400 Hz $\pm$ 10% 250 VA maximum		
<b>WEIGHT .....</b>	< 27 kg (60 lbs).		



Table 1-4. Typical Signal Generator Performance

FREQUENCY (10-DIGIT DISPLAY)	
RANGE .....	0.01 to 1056 MHz in 7 bands:
BAND .01-15 MHz .....	0.01 to 14.999999 MHz,
BAND 15-32 MHz .....	15 to 31.999999 MHz,
BAND 32-64 MHz .....	32 to 63.999999 MHz,
BAND 64-128 MHz .....	64 to 127.999999 MHz,
BAND 128-256 MHz .....	128 to 255.999999 MHz,
BAND 256-512 MHz .....	256 to 511.999999 MHz,
BAND 512-1056 MHz .....	512 to 1056 MHz.
RESOLUTION .....	1 Hz
ACCURACY .....	Same as reference (See REFERENCE).
REFERENCE (Internal) .....	The unit operates on an internal 10 MHz TCXO. The Frequency variation will be < 2 ppm peak to peak over the temperature range of 0 to +50°C. Aging rate of < ± 1 ppm/year typical.
	Internal reference signal (10 MHz) available at rear panel REF OUT connector, level > 0 dBm, terminated in 50 ohms.
	Frequency stability after 2 hour warmup is < ± 0.05 ppm/hour at +25°C ± 5°C.
REFERENCE (External) .....	Accepts (1, 2, or 5) or 10 MHz signal. Level required is 0.2 to 2.0 Vrms into 50-ohms termination.
<b>NOTE</b>	
<i>Choice is internal switch selectable (1, 2, or 5 MHz).</i>	
AMPLITUDE (3 1/2-DIGIT DISPLAY)	
RANGE .....	+19 to -140 dBm for Frequency < 512 MHz. +16 to -140 dBm for Frequency > 512 MHz.
RESOLUTION .....	0.1 dB (< 1% or 1 nV in volts). Annunciators for dB, dBm, dBf, V, mV, μV, dB mV, dB μV, and EMF.
ACCURACY .....	± 1 dB from +19 to -127 dBm and for F from 0.4 to 512 MHz.
(+23 ± 50°C)	± 1 dB from +16 to -127 dBm and for F > 512 MHz.
ACCURACY .....	± 1.5 dB from +19 to -127 dBm and for from 0.4 to 512 MHz.
(0 to +50°C)	± 1.5 dB from +16 to -127 dBm and for F > 512 MHz.

Table 1-4. Typical Signal Generator Performance (cont)

	$\pm 2$ dB from +19 to -100 dBm and for F from 0.01 to 0.4 MHz.
	$\pm 3$ dB from -100 to -127 dBm and for F from 0.01 to 0.4 MHz.
SOURCE VSWR .....	< 1.5:1 for levels below +1 dBm, < 2.0:1 elsewhere.
FLATNESS (+23 $\pm$ 5°C) .....	$\pm 0.5$ dB @ +10 dBm. F > 0.1 MHz.
FLATNESS (0 to + 50°C) .....	$\pm 0.75$ dB @ +10 dBm. F > 0.1 MHz.
<b>SPECTRAL PURITY (CW ONLY)</b>	
NON-HARMONIC SPURIOUS .....	< -100 dBc for offsets greater than 10 kHz.
<i>NOTE</i>	
<i>Fixed frequency spurs are &lt; -100 dBc or &lt; -140 dBm whichever is larger.</i>	
<i>NOTE</i>	
<i>dBc refers to decibels relative to the carrier frequency, or in this case, relative to the signal level.</i>	
HARMONICS .....	< -30 dBc for levels < +13 dBm. < -25 dBc for levels < +16 dBm.
SUBHARMONICS .....	None
POWER LINE SPURIOUS .....	< -50 dBc within $\pm 10$ kHz of carrier.
RESIDUAL FM (RMS in 0.3- to 3-kHz band) .....	< 0.2 Hz for .01 to 15 MHz Band < 0.2 Hz for 15 to 32 MHz Band < 0.2 Hz for 32 to 64 MHz Band < 0.2 Hz for 64 to 128 MHz Band < 0.2 Hz for 128 to 256 MHz Band < 0.5 Hz for 256 to 512 MHz Band < 1 Hz for 512 to 1056 MHz Band
RESIDUAL FM (RMS in 0.05- to 15-kHz band) .....	< 0.5 Hz for .01 to 15 MHz Band < 0.5 Hz for 15 to 32 MHz Band < 0.5 Hz for 32 to 64 MHz Band < 0.5 Hz for 64 to 128 MHz Band < 0.5 Hz for 128 to 256 MHz Band < 1 Hz for 256 to 512 MHz Band < 2 Hz for 512 to 1056 MHz Band
SSB PHASE NOISE .....	< -131 dBc/Hz @ 20 kHz offset @ Frequency = 250 MHz

Table 1-4. Typical Signal Generator Performance (cont)

	< -136 dBc/Hz @ 20 kHz offset @ Frequency = 1 GHz
	< -140 dBc/Hz @ 20 kHz offset @ Frequency = 500 MHz
<b>BROADBAND SSB PHASE</b>	
NOISE FLOOR .....	< -140 dBc/Hz @ 100 kHz offset @ +13 dBm.
RESIDUAL AM (in 0.05- to 15-kHz Band)	< -80 dBc.
<b>AMPLITUDE MODULATION (3-DIGIT DISPLAY)</b>	
(Amplitude < +10 dBm)	
INDICATED DEPTH RANGE .....	0 to 99.9%.
RESOLUTION .....	0.1%.
ACCURACY (0 to 90%) .....	±(2% AM + 4% of setting) at 1 kHz rate
DISTORTION .....	< 1.5% THD to 30% AM
(rate = 1 kHz)	< 3% THD to 70% AM
	< 5% THD to 90% AM
BANDWIDTH (3 dB) .....	10 Hz to 100 kHz
	DC to 100 kHz (external only)
INCIDENTAL FM .....	< 200 Hz at 1 kHz rate, 50% AM.
<b>NOTE</b>	
<i>AM specifications apply where RF frequency - Modulation Frequency is greater than 150 kHz</i>	
<b>FREQUENCY MODULATION (3-DIGIT DISPLAY)</b>	
DEVIATION RANGES .....	0 to 999 Hz
	1 to 9.99 kHz
	10 to 99.9 kHz
	100 to 999 kHz
	1 to 4 MHz
MAXIMUM DEVIATION .....	DEV                      RF Frequency
	500 kHz                  .01 to 15 MHz
	125 kHz                  15 to 32 MHz
	250 kHz                  32 to 64 MHz
	500 kHz                  64 to 128 MHz
	1 MHz                    128 to 256 MHz
	2 MHz                    256 to 512 MHz
	4 MHz                    512 to 1056 MHz

**INTRODUCTION AND SPECIFICATIONS**

**Table 1-4. Typical Signal Generator Performance (cont)**

	Minimum FM rate at max deviation in any band, ACFM mode is 60 Hz. @ 1/2 max deviation....30 Hz @ 1/4 max deviation....15 Hz from 1/4 to 1/64 max deviation.... 15 Hz @ 1/64 max deviation.... 60 Hz @ 1/128 max deviation.... 40 Hz @ 1/256 or less max deviation.... 15 Hz  No limit in DCFM mode.		
RESOLUTION .....	3 digits.		
ACCURACY .....	±(5% of setting + 10 Hz) for rates of .05 to 50 kHz.		
DISTORTION .....	< 2% THD for rates from .05 to 50 kHz (does not include effects of residual noise) < 1% THD at 1/2 or less max deviation and rates from 0.1 to 50 kHz.		
LOW DISTORTION MODE .....	< 0.3% THD + noise @ 3.5 kHz deviation and @ (SPCL 731) rates from 0.3 to 3 kHz		
BANDWIDTH (1.5 dB) .....	ACFM 20 Hz to 100 kHz subject to low frequency max deviation limits  DCFM DC to 100 kHz		
INCIDENTAL AM .....	< 1% AM at 1 kHz rate, for the maximum deviation or 100 kHz, whichever is less. Valid for RF frequency > 0.5 MHz		
DCFM CENTER FREQUENCY ERROR ..	< (0.1% of dev + 500 Hz) @ F = 1 GHz		
<i>NOTE</i>			
<i>After DCFM Cal and without any FM range changes</i>			
LOW RATE EXTERNAL FM .....	RF Band	MAX DEV @ 10 Hz Rate	
(Access by SPCL 711 )		sine wave	square wave
MAX DEVIATION .....	.01 to 15 MHz	80 kHz	40 kHz
	15 to 32 MHz	20 kHz	10 kHz
	32 to 64 MHz	40 kHz	20 kHz
	64 to 128 MHz	80 kHz	40 kHz
	128 to 256 MHz	160 kHz	80 kHz
	256 to 512 MHz	320 kHz	160 kHz
	512 to 1056 MHz	640 kHz	320 kHz
DROOP .....	< 30% on a 5 Hz square wave		
BANDWIDTH (3 dB) .....	0.5 Hz to 100 kHz (typical)		

Table 1-4. Typical Signal Generator Performance (cont)

MAX DC INPUT .....	± 10 mV	
INCIDENTAL AM .....	< 1% AM @ 1 kHz rate and < 10 kHz dev	
<b>NOTE</b>		
<i>FM specifications apply where:</i>		
RF Frequency - Deviation > 150 kHz		
RF Frequency - Mod Rate > 150 kHz		
<b>PHASE MODULATION (3 DIGIT DISPLAY)</b>		
DEVIATION RANGES .....	0 to .999 rad 1 to 9.99 rad 10 to 99.9 rad 100 to 400 rad	
MAXIMUM DEVIATION .....	DEV	RF FREQUENCY
	50 rad	.01 to 15 MHz
	12.5 rad	15 to 32 MHz
	25 rad	32 to 64 MHz
	50 rad	64 to 128 MHz
	100 rad	128 to 256 MHz
	200 rad	256 to 512 MHz
	400 rad	512 to 1056 MHz
RESOLUTION .....	3 digits	
ACCURACY .....	±(5% + 0.1 rad) at 1 kHz rate.	
DISTORTION .....	< 2% THD for 1 kHz rate.	
(does not include effects of residual Phase noise)	< 1% THD for 1/2 or less max deviation for 1 kHz rate	
BANDWIDTH (3 dB) .....	ACPM 20 Hz to 15 kHz DCPM DC to 15 kHz	
INCIDENTAL AM .....	< 1% AM at 1 kHz rate for peak dev < 10 rad. Valid for F > 1 MHz.	
HIGH RATE PHASE MODULATION .....	MAX DEV	RF FREQUENCY
(Access by SPCL 721)		
	5 rad	.01 to 15 MHz
	1.25 rad	15 to 32 MHz
	2.5 rad	32 to 64 MHz
	5 rad	64 to 128 MHz
	10 rad	128 to 256 MHz
	20 rad	256 to 512 MHz
	40 rad	512 to 1056 MHz

## INTRODUCTION AND SPECIFICATIONS

Table 1-4. Typical Signal Generator Performance (cont)

HIGH RATE PHASE MODULATION .....	ACPM 20 Hz to 100 kHz
BANDWIDTH (3 dB) (Access by SPCL 721)	DCPM DC to 100 kHz
<i>NOTE</i>	
<i>Phase Modulation specs are valid where RF Frequency – Modulation Frequency &gt; 150 kHz</i>	
<b>PULSE MODULATION (RF FREQUENCIES FROM 10 TO 1056 MHz)</b>	
ON/OFF RATIO .....	40 dB minimum for frequencies from 100 to 1056 MHz 60 dB minimum for frequencies less than 100 MHz
RISE & FALL TIMES .....	< 15 ns
LEVEL ERROR .....	For pulse widths > 50 ns, power in the pulse will be within $\pm 0.7$ dB of the measured CW level.
DUTY CYCLE (ext mod) .....	0-100%
REP RATE (ext mod) .....	DC-16 MHz
INTERNAL MODULATION .....	Internal rates, approx 50% duty cycle.
EXTERNAL PULSE MODULATION .....	The pulse input is TTL compatible and 50 ohm terminated with an internal active pull-up. It can be modeled as 1.2V in series with 50 ohms at the pulse modulation input connector. The signal generator senses input terminal voltage and turns the RF off when the terminal voltage drops below $1 \pm 0.1$ V. Max allowable applied voltage, $\pm 10$ V.
<b>PULSE MODULATION (RF FREQUENCIES &lt; 10 MHz)</b>	
RISE & FALL TIMES .....	< 2 X period of RF Frequency.
LEVEL ERROR .....	For pulse widths > 10 X period of RF Frequency, power in the pulse will be within $\pm 0.7$ dB of the measured CW level.
Other specifications are the same as for the 10 to 1056 MHz range.	
<b>NON-VOLATILE MEMORY</b>	
50 instrument states are retained for typically 2 years, even with the power mains disconnected.	
<b>REVERSE POWER PROTECTION</b>	
PROTECTION LEVEL .....	Up to 50 watts from a 50 ohm source, up to 50V DC. Signal generator output is AC coupled. Protection is provided when the signal generator is off.

Table 1-4. Typical Signal Generator Performance (cont)

TRIP/RESET .....	Flashing RF OFF annunciator indicates a tripped condition. Pushing RF ON/OFF button will reset signal generator.
<b>IEEE-488</b>	
INTERFACE FUNCTIONS .....	SH1, AH1, T5, TE0, L3, LE0, SR1, RL1, PP0, DC1, DT1, C0, and E2.
<b>INTERNAL MODULATION SOURCE</b>	
SINE WAVE .....	0.1 Hz to 200 kHz synthesized sine wave.
FREQUENCY ACCURACY .....	Same as reference $\pm 7$ mHz
DISPLAY RANGES .....	00.1 to 99.9 Hz 100 to 999 Hz 1.00 to 9.99 kHz 10.0 to 99.9 kHz 100 to 200 kHz
FREQUENCY RESOLUTION .....	0.1 Hz or 3 digits
OUTPUT LEVEL RANGE .....	0 to 4V peak into 600 ohms
OUTPUT LEVEL RESOLUTION .....	3 digits or 4 mv peak, whichever is larger
DISTORTION .....	< 0.15% THD for output levels > 2V peak and mod frequency < 20 kHz
OUTPUT LEVEL ACCURACY .....	$\pm(4\% + 15 \text{ mV})$ for mod frequency < 100 kHz
OUTPUT IMPEDANCE .....	600 ohms $\pm 2\%$
OTHER WAVEFORMS AVAILABLE BY SPECIAL FUNCTION .....	Square Wave (Fmod < 2 kHz) Triangle Wave (Fmod < 5 kHz)
<b>EXTERNAL MODULATION INPUTS</b>	
1V peak provides indicated modulation index. Nominal input impedance is 600 ohms. Maximum input level is $\pm 5$ V peak.	
<b>MODULATION MODES</b>	
Any combination of AM, PULSE, and FM or $\emptyset$ M, internal or external, may be used.	
<b>DIGITAL FREQUENCY SWEEP</b>	
SWEEP MODES .....	Auto, single, or manual

Table 1-4. Typical Signal Generator Performance (cont)

SWEEP FUNCTIONS .....	Symmetrical sweep, Asymmetrical sweep, Sweep speed
DATA ENTRY PARAMETERS .....	Sweep width and sweep increment
SWEEP SPEED .....	Minimum 40 ms per increment selectable as (minimum + dwell time) where dwell time can be 0, 20, 50, 100, 200, or 500 ms at each increment.
SWEEP OUTPUT .....	0 to +10 ( $\pm 10\%$ ) V. Up to 4096 points in a stepped ramp. Load > 2 k $\Omega$ .
PENLIFT .....	TTL, high for retrace. Load > 2 k $\Omega$ .
<b>DIGITAL AMPLITUDE SWEEP</b>	
SWEEP MODES .....	Auto, single, or manual Linear (Volts) or Log (dB)
SWEEP FUNCTIONS .....	Symmetrical sweep, Asymmetrical sweep, Sweep speed
DATA ENTRY PARAMETERS .....	Sweep width and sweep increment
SWEEP SPEED .....	Minimum 30 ms per increment selectable as (minimum + dwell time) where dwell time can be 0, 20, 50, 100, 200, or 500 ms at each increment.
SWEEP OUTPUT .....	0 to +10 ( $\pm 10\%$ ) V. Up to 4096 points in a stepped ramp. Load > 2 k $\Omega$ .
PENLIFT .....	TTL, high for retrace. Load > 2 k $\Omega$ .
<b>GENERAL</b>	
<b>TEMPERATURE</b>	
Operating .....	0 to +50°C (+32 to +122°F).
Non-Operating .....	-40 to +75°C (-40 to +167°F).
<b>HUMIDITY RANGE</b>	
Operating .....	95% to +30°C, 75% to +40 °C, and 45% to +50°C.
<b>ALTITUDE</b>	
Operating .....	Up to 10,000 ft.
<b>VIBRATION</b>	
Non-Operating .....	5 to 15 Hz at 0.06 inch, 15 to 25 Hz at 0.04 inch, and 25 to 55 Hz at 0.02 inch, double amplitude (DA).
<b>SHOCK</b>	
Non-Operating .....	Per MIL T 28800D Class 5, Style E.



Table 1-4. Typical Signal Generator Performance (cont)

ELECTROMAGNETIC COMPATIBILITY..	The radiated emissions induce < 1 $\mu$ V into a 1-inch diameter, 2-turn loop, 1-inch from any surface as measured into a 50-ohm receiver.		
COMPLIES WITH THE FOLLOWING STANDARDS:			
	CE03 of MIL-STD-461B (Power and interconnecting leads), 0.015 to 50 MHz.		
	RE02 of MIL-STD-461B (14 kHz to 10 GHz).		
	FCC Part 15 (J), class A.		
	CISPR 11.		
SIZE .....	Width	Height	Depth
	43 cm	13.3 cm	59.7 cm
	17 in	5.25 in	23.5 in
POWER .....	115/230 VAC, $\pm 10\%$ 50, 60, & 400 Hz $\pm 10\%$ < 250 VA		
WEIGHT .....	< 27 kg (60 lbs).		
<b>SUPPLEMENTAL CHARACTERISTICS</b>			
The following characteristics are provided to assist in the application of the signal generator and to describe the typical performance that can be expected.			
FREQUENCY SWITCHING SPEED .....	< 100 ms to be within 100 Hz.		
AMPLITUDE SWITCHING SPEED .....	< 100 ms to be within 0.1 dB.		
AMPLITUDE RANGE .....	Programmable from +20 to -147.4 dBm. Fixed-range, selected by special function, allows for more than 12 dB of vernier without switching the attenuator.		
EXTERNAL MODULATION .....	Annunciators indicate when a 1V peak signal is applied, $\pm 2\%$ , over a 0.02- to 100-kHz band.		
IEEE	All controls except the power switch and the internal/ external reference switch are remotely programmable via IEEE-488 Interface (Std 488.2-1987). All status including the option complement are available remotely.		
EXTERNAL REFERENCE LOCK RANGE	$\pm 10$ ppm		
<b>PULSE MODULATION</b>			
PULSE DELAY .....	OFF/ON	80 ns typ	
	ON/OFF	65 ns typ	

**Table 1-4. Typical Signal Generator Performance (cont)**

DCFM DRIFT .....	3 ppm/hr for < 1/16 max deviation
(after 2 hour warmup and at constant temperature)	8 ppm/hr for > 1/16 max deviation

# Section 2 Installation

## **INTRODUCTION**

**2-1.**

Section 2 describes the installation of the 6080A/AN Synthesized RF Signal Generator and preparation for use. It includes power requirements, line voltage selection and fuse replacement procedures, rack mounting instructions, and configuration of the signal generator for local and remote operation.

## **INITIAL INSPECTION**

**2-2.**

The 6080A/AN is shipped in a special protective container that should prevent damage during shipment. Check the shipping order against the contents of the container and report any damage or short shipment to the place of purchase or the nearest Fluke Technical Service Center. Instructions for inspection and claims are included on the shipping container.

If reshipment of the 6080A/AN is necessary, please use the original shipping container. If the original container is not available, use a container that provides adequate protection during shipment. It is recommended that the 6080A/AN be protected by at least three inches of shock-absorbing material on all sides of the container. Do not use loose fill to pad the shipping container. Loose fill allows the 6080A/AN to settle to one corner of the shipping container, which could result in damage during shipment.

## **SERVICE INFORMATION**

**2-3.**

### **Warranty**

**2-4.**

Each John Fluke Model 6080A/AN Synthesized RF Signal Generator is warranted for a period of 2 years upon delivery to the original purchaser. The warranty is located at the front of this manual.

### **Service**

**2-5.**

Factory authorized service for the 6080A/AN is available at selected John Fluke Technical Service Centers. For service, return the signal generator to the nearest John Fluke Technical Service Center. The local service center will handle transportation to and from the selected service center as required. A complete list of John Fluke Technical Service Centers is provided in the Service Manual.

**SETTING UP THE 6080A/AN** **2-6.**

**Power Requirements** **2-7.**

The 6080A/AN uses a line voltage of 115V AC  $\pm$  10% with a 2.0A fuse; or 230V AC  $\pm$  10% with a 1.0A fuse. The line frequency must be between 45 and 66 Hz or between 360 and 440 Hz. The power consumption of the signal generator is less than 200 VA.

**Line Voltage Selection and Fuse Replacement** **2-8.**

**CAUTION**

**Verify that the intended line power source matches the line voltage setting of the 6080A/AN before plugging in the line power cord.**

Refer to Figure 2-1 to set the line voltage of the 6080A/AN to match the available source. Figure 2-1 also shows how to replace the line fuse of the 6080A/AN. The correct fuse value for each of the two line voltages is listed on a plate attached to the rear panel of the 6080A/AN.

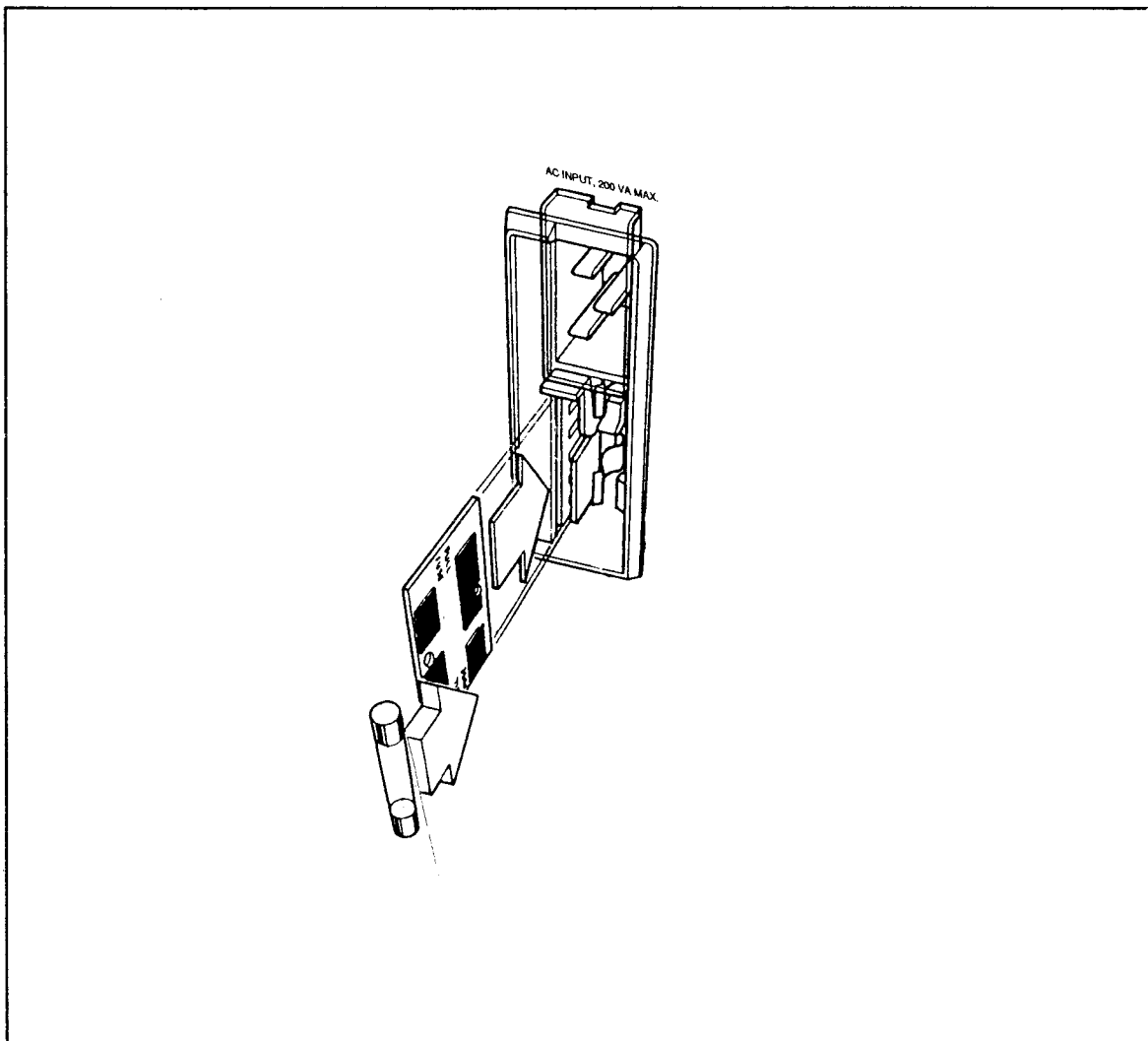

**Figure 2-1. Fuse/Line Voltage Selection Assembly**

## Rack or Bench Mounting the 6080A/AN 2-9.

### CAUTION

**Allow at least 3 inches of clearance behind and on each side of the 6080A/AN to ensure proper air circulation.**

The 6080A/AN may be placed directly on a work bench or mounted in a standard (24-inch deep) equipment rack. Use the Fluke Y6001 Rack Mount Kit for mounting the 6080A/AN in an equipment rack. Instructions for installing the 6080A/AN with the Rack Mount Kit are provided in the kit. The outside dimensions of the 6080A/AN are shown in Figure 2-2. The Rack Mount Kit is composed of a 5 ¼-inch Rack Adapter (P/N M05-205-600) and 24-inch Rack Slides (P/N M00-280-610).

## Frequency Reference 2-10.

The 6080A/AN normally operates with an internal reference oscillator. However, if desired, the 6080A/AN can be operated with an external reference by setting the rear panel REF INT/EXT switch to EXT and connecting the external reference to the REF IN connector.

### CAUTION

**When the 6080A/AN is operating on its internal reference, a 10-MHz signal is present at the 10 MHz OUT connector. To meet the specified radiated emissions, this connector must be terminated with a BNC non-shorting dust cap. A dust cap, JF 478982, is supplied with the 6080A/AN. If a cable is connected, it must be a double-shielded coaxial cable such as RG-223 terminated in a 50-ohm load.**

### CAUTION

**Output spectral degradation occurs if the 6080A/AN is operated on internal reference with an external reference signal applied.**

## Local and Remote Operation 2-11.

The 6080A/AN output is controlled by either Local (Front Panel) operation or Remote operation. In the Local operation mode, keys on the front panel are used to control the 6080A/AN. In the Remote operation mode, a IEEE-488 controller is used to send programming commands to control the 6080A/AN through the IEEE-488 Interface, to query and receive instrument state messages, and to exchange synchronization signals.

### NOTE

*To meet the specified radiated emissions, the IEEE-488 connector must be terminated with a shielded IEEE-488 cable, such as a Fluke Y8021.*

## Power-On Sequence 2-12.

When the 6080A/AN is turned on, a power-on sequence starts. During the power-on sequence, the microprocessor tests the front panel display, the analog circuitry, the instrument RAM, and the nonvolatile memory containing the compensation and calibration data, and. The front panel display is tested by lighting all segments for a brief period as the rest of the self-tests are performed.

If any of the self-tests fail, one or more status codes are displayed. Any front panel entry that occurs before the power-on sequence is completed aborts the self-test, and sets the 6080A/AN to instrument preset state. The Instrument Preset State is described in Appendix A. The power-on self-tests are explained in detail in the Service Manual.

# INSTALLATION

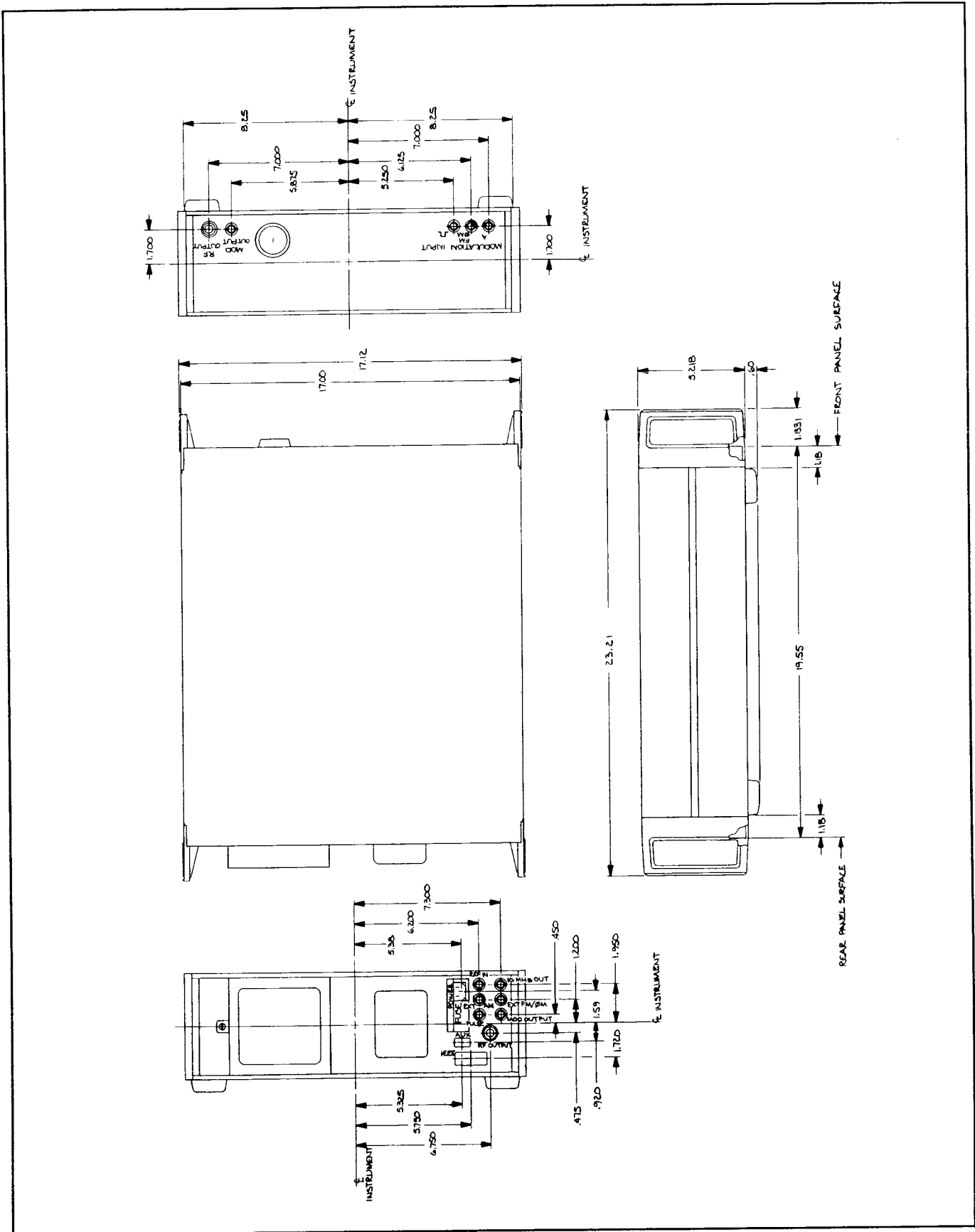

Figure 2-2. 6080A/AN Outside Dimensions

# Section 3

## Signal Generator Features

### **GENERAL INFORMATION** **3-1.**

Section 3 is a reference for the functions and locations of the front panel and rear panel features of the 6080A/AN Signal Generator. Please read this information before operating the signal generator. Front panel operating instructions are provided in Section 4, “Front Panel Operation”, and remote operating instructions are provided in Section 5, “Remote Operation”.

### **FRONT PANEL FEATURES** **3-2.**

Figure 3-1 shows the front panel and Tables 3-1 and 3-2 describe its features.

#### **Display Features** **3-3.**

Table 3-1 describes the display features of the front panel.

#### **Front Panel Keys and Connectors** **3-4.**

Table 3-2 describes the front panel keys and connectors.

### **REAR PANEL FEATURES** **3-5.**

Figure 3-2 shows the rear panel. Table 3-3 describes rear panel features.

# SIGNAL GENERATOR FEATURES

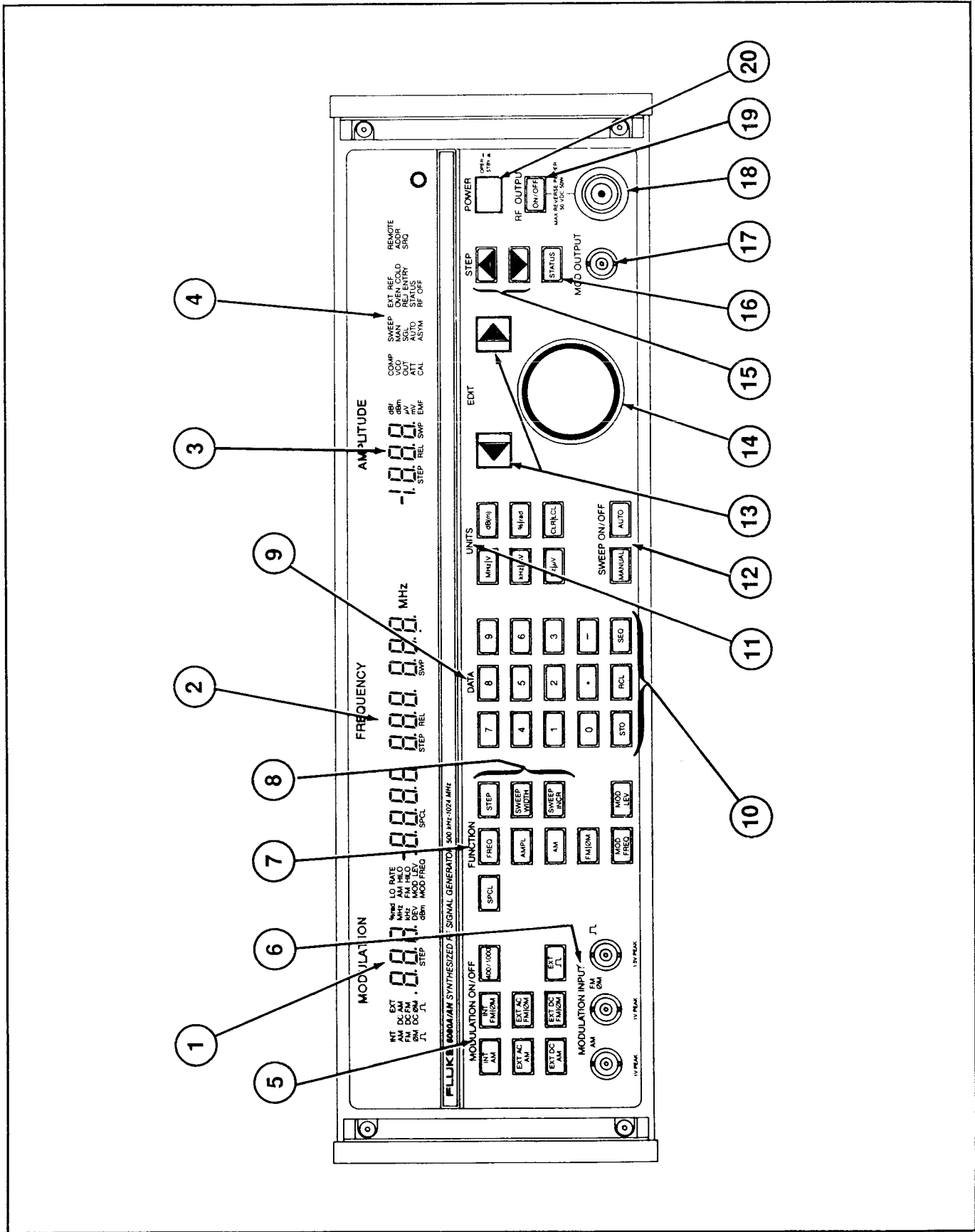



Figure 3-1. Front Panel Features



Table 3-1. Front Panel Display Features

①	<b>MODULATION DISPLAY FIELD</b>	A three-digit display, with associated annunciators, used to display the AM depth, FM/ØM deviation, source of modulation signal, modulation frequency and modulation level. It is also used to display active error codes and status codes.
	INT AM	Indicates that the internal modulation oscillator signal is amplitude modulating the 6080A/AN.
	INT FM	Indicates that the internal modulation oscillator signal is frequency modulating the 6080A/AN.
	INT ØM	Indicates that the internal modulation oscillator signal is phase modulating the 6080A/AN.
	INT 	Indicates that the internal modulation oscillator signal is pulse modulating the 6080A/AN.
	EXT AM	Indicates that the 6080A/AN is amplitude modulated by the signal connected to the AM MODULATION INPUT connector, AC coupled.
	EXT DC AM	Indicates that the 6080A/AN is amplitude modulated by the signal connected to the AM MODULATION INPUT connector, DC coupled.
	EXT FM	Indicates that the 6080A/AN is frequency modulated by the signal connected to the FM/ØM MODULATION INPUT connector, AC coupled.
	EXT DC FM	Indicates that the 6080A/AN is DC frequency modulated by the signal connected to the FM/ØM MODULATION INPUT connector.
	EXT ØM	Indicates that the 6080A/AN is phase modulated by the signal connected to the FM/ØM MODULATION INPUT connector, AC coupled.
	EXT DC ØM	Indicates that the 6080A/AN is phase modulated by the signal connected to the FM/ØM MODULATION INPUT connector, DC coupled.
	EXT 	Indicates that the 6080A/AN is pulse modulated by the signal connected MODULATION INPUT connector.
	STEP	Indicates that the Step Size Entry, and Step Increment and Decrement keys affect the displayed Modulation parameter.
	%	Indicates that the value displayed is the AM Depth in percent.
	MHz kHz DEV	Indicates that the value displayed is the FM Deviation in MHz, kHz, or Hz.
	rad	Indicates that the value displayed is the Phase Modulation Deviation in radians.

## SIGNAL GENERATOR FEATURES

Table 3-1. Front Panel Display Features (cont)

	dBm	Indicates that the value displayed is the target level in dBm when performing a level calibration/compensation procedure.
	LO RATE	Indicates that the 6080A/AN is in low-rate FM modulation mode.
	AM HI	Indicates that the external AC AM modulation signal is more than 2% above the nominal 1V peak requirement for calibrated operation.
	AM LO	Indicates that the external AC AM modulation signal is more than 2% below the nominal 1V peak input requirement.
	FM HI	Indicates that the external AC FM modulation signal is more than 2% above the nominal 1V peak requirement for calibrated operation.
	FM LO	Indicates that the external AC FM modulation signal is more than 2% below the nominal 1V peak input requirement.
	V MOD LEV	Indicates that the value displayed is the Peak Modulation Output Level in Volts.
	MHz kHz MOD FREQ	Indicates that the value displayed is the Modulation Frequency in MHz, kHz, or Hz.
②	<b>FREQUENCY DISPLAY FIELD</b>	A signed ten-digit display with four annunciators, used to display the RF Frequency parameters of the 6080A/AN. It is also used to display Special Function codes, status codes, or stored/recalled memory location codes.
	STEP	Indicates that the Step Size Entry and the Step Increment and Decrement keys affect the RF frequency.
	REL	Indicates that the displayed frequency is relative to a reference frequency.
	SPCL	Indicates certain Special Functions are enabled that are not otherwise annunciated. Pressing the [SPCL] key causes the enabled Special Function codes to be displayed.
	SWP	Indicates that the SWEEP ON/OFF keys apply to frequency sweep.
③	<b>AMPLITUDE DISPLAY FIELD</b>	A signed three and one-half digit display, with eight annunciators, used to display the RF Amplitude parameters of the 6080A/AN. It is also used to display status codes.
	STEP	Indicates that the Step Size Entry and the Step Increment and Decrement keys affect the RF amplitude.
	REL	Indicates that the displayed amplitude is relative to a reference amplitude.
	SWP	Indicates that the SWEEP ON/OFF keys apply to amplitude sweep.

Table 3-1. Front Panel Display Features (cont)

	dBf	Indicates that the displayed amplitude is in decibels relative to one femtowatt.
	dB	Indicates that the displayed amplitude is in decibels relative to a reference amplitude, or is a step size value, a sweep increment value, or a sweep width value.
	dBm	Indicates that the displayed amplitude is in decibels relative to one milliwatt.
	V $\mu$ V mV	Indicates that the displayed amplitude is in volts, microvolts, or millivolts.
	dB mV	Indicates that the displayed amplitude is in decibels relative to one millivolt.
	dB $\mu$ V	Indicates that the displayed amplitude is in decibels relative to one microvolt.
	EMF	Indicates that the displayed amplitude is in EMF units.
④	<b>STATUS DISPLAY</b>	The status display field is composed of 17 annunciators and a yellow LED, used to denote the status of the 6080A/AN.
	COMP	Indicates that a compensation procedure is in progress. Flashes when the rear panel CAL COMP switch is set to 1 (ON).
	VCO	Indicates that a coarse loop, sum loop, or subsynthesizer compensation procedure is in progress.
	OUT	Indicates that an output compensation procedure is in progress.
	ATT	Indicates that an attenuator compensation procedure is in progress.
	CAL	Indicates that a calibration procedure is in progress. Flashes when the rear panel CAL COMP switch is set to 1 (ON).
	SWEEP	Indicates that a sweep is active.
	MAN	Indicates that manual sweep mode is active.
	SGL	Indicates that single sweep mode is active.
	AUTO	Indicates that auto sweep mode is active.
	ASYM	Indicates that the 6080A/AN is configured to sweep in asymmetric mode.
	EXT REF	Indicates that the rear panel REF switch is in the EXT (external) position.
	OVEN COLD	Indicates ovened time base oscillators have not stabilized.

## SIGNAL GENERATOR FEATURES

**Table 3-1. Front Panel Display Features (cont)**

REJ ENTRY	Flashes when an invalid entry is made.
STATUS	Indicates when the 6080A/AN is operating outside its specified range. Flashes when a hardware-limited or a hardware fault condition is detected.
RF OFF	Indicates that the RF OUTPUT is disabled.
REMOTE	Indicates that the 6080A/AN is in the remote (IEEE-488 Interface) mode of operation.
ADDR	Indicates that the 6080A/AN is addressed to listen or talk on the IEEE-488 interface.
SRQ	Indicates that the 6080A/AN has asserted the IEEE-488 SRQ signal.
Yellow LED	When illuminated, indicates that the 6080A/AN is in the standby state and is connected to the power mains. The LED is off when the 6080A/AN is operating.

Table 3-2. Front Panel Keys and Connectors













5	<b>MODULATION ON/OFF</b>	Used to select type and source of modulation. With the exception of the 400/1000 key, these keys operate as independent push-on/push-off switches for the given modulation.
		Enables internal amplitude modulation.
		Enables external AC-coupled amplitude modulation using the signal applied to the AM MODULATION INPUT connector.
		Enables external DC-coupled amplitude modulation using the signal applied to the AM MODULATION INPUT connector.
		Enables internal frequency or phase modulation.
		Enables external AC-coupled frequency or phase modulation using the signal applied to the FM/ØM MODULATION INPUT connector.
		Enables external DC frequency or phase modulation using the signal applied to the FM/ØM MODULATION INPUT connector.
		Toggles the internal modulation oscillator frequency between 400 and 1000 Hz. Used as an alternative to the MOD/FREQ key and data input.
		Enables external pulse modulation using the signal applied to the  MODULATION INPUT connector.
6	<b>MODULATION INPUT</b>	
	AM	A BNC connector for input of a 1V peak, external AM modulation signal.
	FM/ØM	A BNC connector for input of a 1V peak, external FM/ØM modulation signal.
		A BNC connector for input of a 1.5V peak, external pulse modulation signal.
7	<b>FUNCTION</b>	These keys are used to select a function parameter to be entered or edited. When pressed, the bright digit appears in the corresponding display field of the selected function.
		Enables the Special Function mode. Special functions are enabled and disabled by using the DATA keys to enter a two-or-three digit numeric code. Refer to Section 4F, "Special Functions" for a detailed description and a list of the special functions.
		Selects the RF frequency parameter to be programmed.
		Selects the RF amplitude parameter to be programmed.





Table 3-2. Front Panel Keys and Connectors (cont)

AM	Selects the amplitude modulation (AM) depth parameter to be programmed.
FM ØM	Selects the frequency or phase modulation (FM or ØM) deviation parameter to be programmed.
MOD FREQ	Selects the modulation frequency parameter to be programmed.
MOD LEV	Selects the modulation level parameter to be programmed.
8	<b>FUNCTION MODIFIERS</b>
STEP	After selecting one of the six functions, pressing this key displays the step size for the parameter and allows a new step size to be entered. The STEP up or down (increase or decrease) keys are enabled for the selected parameter.
SWEEP WIDTH	After the frequency or amplitude function has been selected, pressing this key displays the sweep width for the function and allows a new sweep width to be entered. The SWEEP mode keys are enabled for the selected function.
SWEEP INCR	After the frequency or amplitude function has been selected, pressing this key displays the sweep increment for the function and allows a new sweep increment to be entered. The SWEEP mode keys are enabled for the selected function.
9	<b>DATA</b>
	A 10-digit (plus sign and decimal key) keypad used for entering a parameter value, the Special Function code, or a memory recall/store location.
10	<b>MEMORY OPERATIONS</b>
STO	Used with the DATA keys to store the current instrument state in a memory location. Memory locations 01 through 50 are available. When used in conjunction with any of the six FUNCTION keys, a single function parameter can be stored.
RCL	Used with the DATA keys to recall an instrument state from a memory location. Memory locations 01 through 50 are available for storage of instrument states; memory location 98 contains the Instrument Preset State (Described in Appendix A). When used in conjunction with any of the six FUNCTION keys, a previously stored single function parameter can be recalled.

Table 3-2. Front Panel Keys and Connectors (cont)

11	UNITS	SEQ	Sequentially recalls, in increasing location order, the instrument states stored in memory. While the SEQ key is pressed, successive memory locations are displayed. When the key is released, the location last displayed is recalled. Pressing RCL followed by [ - ] sequentially recalls, in decreasing order, the stored instrument states.
		MHz V	Used with the FREQ, FM/ØM, and MOD FREQ function keys to program the parameter data in units of MegaHertz. Used with the AMPL and MOD LEV function keys to program the parameter data in units of Volts. Used with the Pulse Width entry Special Function to program the parameter data in units of microseconds.
		kHz mV	Used with the FREQ, FM/ØM, and MOD FREQ function keys to program the parameter data in units of kilohertz. Used with the AMPL and MOD/LEV function keys to program the parameter data in units of millivolts. Used with the Pulse Width entry Special Function to program the parameter data in units of milliseconds.
		Hz µV	Used with the FREQ, FM/ØM, and MOD FREQ function keys to program the parameter data in hertz. Used with the AMPL and MOD LEV function keys to program the parameter data in units of microvolts. Used with the Pulse Width entry Special Function to program the parameter data in units of seconds.
		dB(m)	Used with the AMPL function key to program the parameter data in terms of decibels relative to one milliwatt or to an alternate reference if selected by Special Function. Used in relative amplitude mode or with the STEP, SWEEP/WIDTH or SWEEP/INCR function modifier keys to program the parameter data in units of decibels ratio.
		% rad	Used with the AM function key to program the parameter data in units of percentage of AM depth. Used with the FM/ØM function key to program the parameter data in units of radians of ØM deviation.
		CLR LCL	When the 6080A/AN is in local operation, this key is used to clear an entry and return the 6080A/AN to the last valid state. When the signal generator is in remote operation, this key is used to return local control.
		12	SWEEP ON/OFF
AUTO	Used to enable or disable auto sweep mode. The 6080A/AN repetitively progresses through the sweep range for the selected sweep function.		

Table 3-2. Front Panel Keys and Connectors (cont)

13	<b>EDIT</b>	These keys are used to position the bright digit within a display field. Both keys repeat while they are pressed.
		Moves the bright digit one digit to the left in the active display field.
		Moves the bright digit one digit to the right in the active display field.
14	<b>EDIT KNOB</b>	Used to increase or decrease the bright-digit value. The bright digit is moved to the desired display field by pressing the one of the FUNCTION keys.
15	<b>STEP</b>	These two keys work in conjunction with the STEP Function Modifier key. Both keys repeat while they are pressed.
		Used to increment the function parameter with the STEP annunciator lit in the display field by the programmed step size.
		Used to decrement the function parameter with the STEP annunciator lit in the display field by the programmed step size.
16	<b>STATUS</b>	Used to display a Rejected Entry (REJ ENTRY annunciator flashing) or Status codes in the display fields.
17	<b>MOD OUTPUT</b>	A BNC connector for output of the internal modulation oscillator signal.
18	<b>RF CONNECTOR</b>	A standard Type "N" connector for output of the 6080A/AN RF signal.
19	<b>RF OUTPUT</b>	A push-on/push-off key (with a corresponding RF OFF ON/OFF annunciator in the STATUS display field) that controls the RF output of the 6080A/AN.
20	<b>POWER</b>	A push-on/push-to-standby detent switch that enables line power to the 6080A/AN or enables standby power.



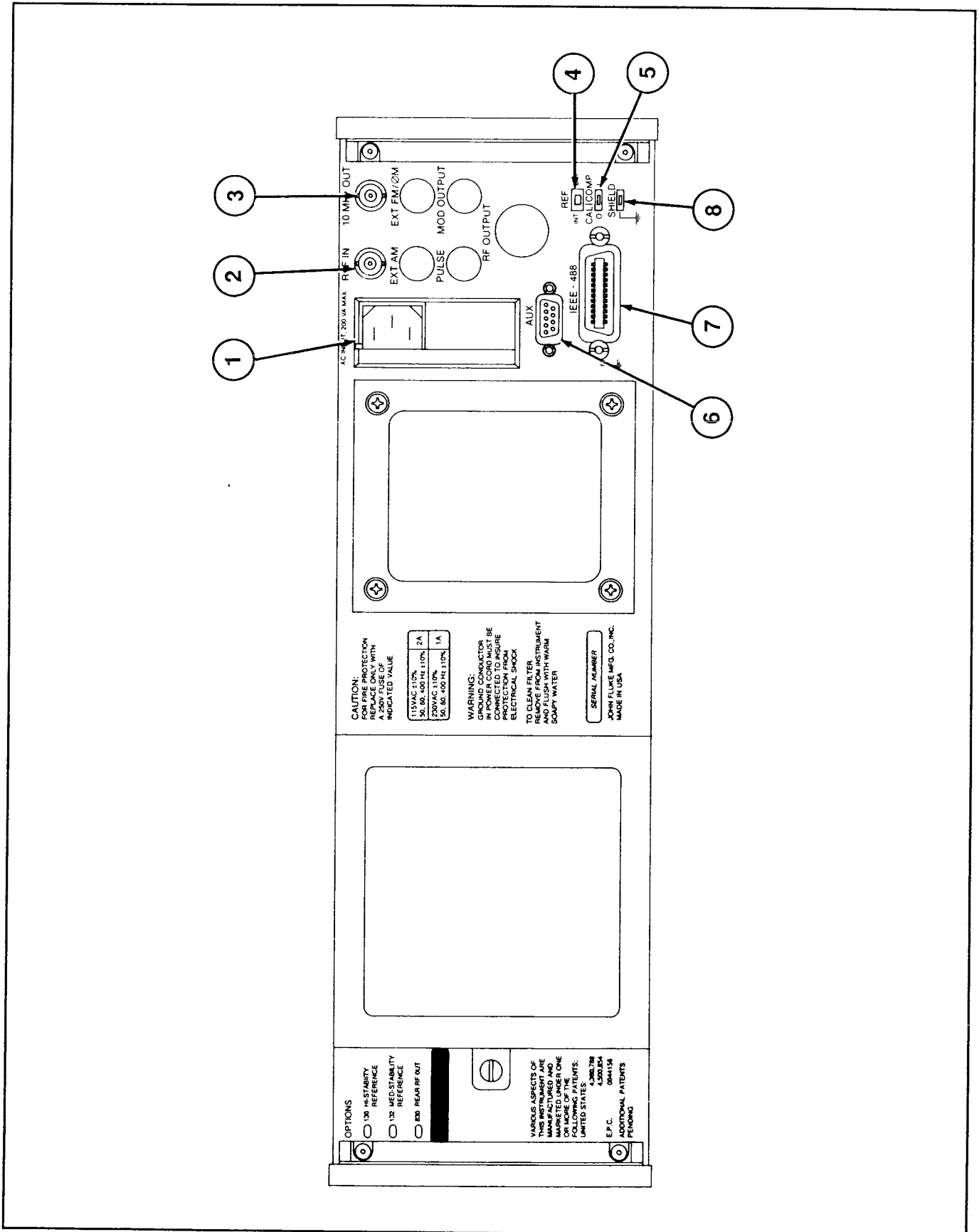



Figure 3-2. Rear Panel Features

## SIGNAL GENERATOR FEATURES

Table 3-3. Rear Panel Features

①	<b>AC INPUT</b>	Permits operation from 115V or 230V, $\pm 10\%$ . The number visible through the window on the selector card indicates the nominal line voltage to which the 6080A/AN must be connected. The line voltage is selected by orienting the selector card appropriately. A 2-ampere fuse is required for 115V operation and a 1-ampere fuse is required for 230V operation.
②	<b>REF INT/EXT</b>	This switch is for selection of the 6080A/AN frequency reference. When set to INT, the 6080A/AN operates on the 10-MHz internal reference. The internal 10 MHz reference signal is available at the 10-MHz OUT connector. When set to EXT, the 6080A/AN reference is a 1-, 2-, 5- or 10-MHz signal applied to the external REF IN connector.
③	<b>10 MHz OUT</b>	This connector (BNC) provides a 10 MHz reference signal to external devices.
④	<b>REF IN</b>	This connector (BNC) is present to accept a 1 MHz, 2 MHz, 5 MHz, or a 10 MHz 0.5 to 2V rms sine or square wave signal into a nominal 50 ohm termination.
⑤	<b>IEEE-488 CONNECTOR</b>	This connector allows remote operation of the 6080A/AN via the IEEE-488 bus.
⑥	<b>AUX</b>	This connector (9-pin D-Subminiature) is for output of the sweep z-axis blanking/penlift, sweep DAC, and for remote control of bright digit and memory sequence up and down operations. See Appendix F for the pinout diagram.
⑦	<b>CAL COMP</b>	This switch, when set to 1 (ON) enables the 6080A/AN to run closed-case calibration and compensation procedures.
⑧	<b>SHIELD</b> 	This switch connects the shield of the IEEE-488 connector and cable to the instrument ground.

# Section 4

## Front Panel Operation

### INTRODUCTION

4-1.

Section 4 describes general front panel operations of the 6080A/AN. (The front panel features are described in Section 3.)

Each of Sections 4A through 4G describes procedures that are specific to one area of signal generator operation. A description of the front panel keystrokes and the equivalent remote (IEEE-488.2) mnemonic commands are provided. For more information on the programming the signal generator via the IEEE-488 bus, refer to Section 5, "Remote Operation".

### PARAMETER ENTRY AND MODIFICATION

4-2.

The six primary parameters of the 6080A/AN Signal Generator (RF frequency, RF amplitude, amplitude modulation (AM) depth, frequency/phase modulation (FM/ $\phi$ M) deviation, modulation frequency and modulation level) may be individually changed by any of three methods:

- Parameter Entry
- Bright-Digit Edit
- Step Increment/Decrement

Each of these methods accomplishes the same result, but each method is particularly suited for a specific application. For example, establish an initial parameter value with the Parameter Entry method, then adjust that parameter with the Bright-Digit Edit or Step Increment/Decrement methods.

### Parameter Entry

4-3.

The sequence of a Parameter Entry is:

#### 1. Select Function

Select one of the six functions using the FUNCTION keys. The bright digit appears in the corresponding display field. The presence of the bright digit in the display field indicates that the selected function parameter is ready to be programmed or changed.

#### 2. Enter Data

Enter the numeric data with the DATA keys. The numerics appear in the selected display field. The bright digit is off when numeric data is being entered.

### 3. Select Unit

Select a UNITS key. This gives the numeric data its absolute value and causes the microprocessor to verify that the entered value is within allowable limits and to program the 6080A/AN to the new state. The bright digit is redisplayed.

Once a function is selected, it remains in the active programming mode until a new function is selected. Parameter data for a selected function must be followed by a unit value and must be within the allowable range for the function. If the data is not within the allowable range, the display field flashes, and the REJECTION status annunciator flashes. A rejected entry does not affect the output of the 6080A/AN. The output of the 6080A/AN remains at its previous values until a new value is accepted.

Function parameter entry may be terminated at any time by the  key or by selecting another function.

In Remote Mode, parameter entry commands are provided for each of the six functions. Refer to Section 5, "Remote Operation" for more information.

## Bright-Digit Edit



4-4.

The sequence of a Bright-Digit Edit is:

### 1. Select Display Field

Select one of the six functions using the FUNCTION keys. The bright digit appears in the corresponding display field.

### 2. Position Bright Digit

Use the  or  EDIT keys to position the bright digit to the desired decade of resolution.

### 3. Change Bright-Digit Value

Use the knob to increase (turn clockwise) or decrease (turn counterclockwise) the value of the bright digit.

The position of the bright digit within a display field is retained when the bright digit is moved from one display field to another and back to the original field. Note that each of the functions that shares the MODULATION display field (AM Depth, FM/ $\phi$ M Deviation, Modulation Frequency and Modulation Level) maintain a unique copy of the bright digit position.

The bright digit is turned off while Manual Sweep is active. Refer to Section 4E, "Sweep" for more information.

An edit operation is ignored when the result would cause the value of the edited parameter to exceed its programmable limit.

In Remote Mode, both bright digit positioning and editing commands are provided for each of the six functions. Refer to Section 5, "Remote Operation" for more information.

**Step Increment and Decrement****4-5.**

The sequence for step entries is:

1. Select Step Field

Select the field to be changed stepwise using one of the FUNCTION keys, followed by the  key to enable the step size entry.

2. Enter Data

Program the numeric step size using the DATA keys.

3. Select Units

Select a UNIT key to give the data its absolute value.

4. Step Function Parameter

The parameter can now be changed in increments of the step size using the  or  STEP keys. The step size for a given function remains in effect until a new step size is selected.

While the  key is pressed, the display field of the selected parameter shows the step size. The STEP annunciator is lit in the display field affected by the  key.

The repeat rate of the  or  STEP keys may be changed to a faster or slower rate (a medium repeat rate is the default) with a Special Function. Refer to Section 4F, "Special Functions" for more information.

A step increment or decrement is ignored when the result of that step would cause the value of the stepped parameter to exceed its programmable limit.

In Remote Mode, both step entry and step up/down commands are provided for each of the six functions. Refer to Section 5, "Remote Operation" for more information.



# Section 4A

## RF Frequency

### INTRODUCTION

4A-1.

Section 4A describes the procedures for programming the RF frequency and the associated parameters of RF frequency.

### RF FREQUENCY ENTRY

4A-2.

The RF frequency can be controlled with the FUNCTION-DATA-UNIT entry sequence. The frequency display is a fixed-point display in MHz. Pressing the **FREQ** key moves the bright digit to the FREQUENCY display field and places the 6080A/AN in the RF frequency entry mode.

RF FREQUENCY	
RANGE	RESOLUTION
0.01 to 1056 MHz	1 Hz

SYNTAX:

**FREQ** --Numeric Data-- **MHz|V**  
**kHz|mV**  
**Hz| $\mu$ V**

EXAMPLE: Set RF Frequency to 10.7 MHz

FRONT PANEL: **FREQ** **1** **0** **.** **7** **MHz|V**

REMOTE: FREQ 10.7 MHZ

### RF FREQUENCY STEP ENTRY

4A-3.

The RF frequency step size can be selected for entry by pressing the **FREQ** key, followed by the **STEP** key. As long as the **STEP** key is pressed, the step size is displayed. Upon entering a new step size, the value is held momentarily in the FREQUENCY display field.

## FRONT PANEL OPERATION

### RF FREQUENCY

#### RF FREQUENCY STEP SIZE

RANGE	RESOLUTION
0 to 1056 MHz	1 Hz

SYNTAX:

-- Numeric Data--

EXAMPLE: Set RF Frequency Step Size to 103 kHz

FRONT PANEL:

REMOTE: FREQ\_STEP 103 KHZ

## RF FREQUENCY RELATIVE MODE

**4A-4.**

The RF frequency relative mode is useful for establishing a reference frequency and then changing the output relative to that reference. Setting a reference is done by programming the RF frequency to the desired value, and then enabling the relative mode using a Special Function command from the front panel, or with the `FREQ_REL` command from Remote. This causes the REL annunciator to light in the FREQUENCY display field and the displayed value to become zero. The 6080A/AN output does not change during this operation. In the relative mode, the usual means of parameter modification may be used: Function Entry, Bright-Digit Edit, or Step Increment/Decrement.

In the relative frequency mode, the output RF frequency is the sum of the reference and the displayed frequency. The output RF frequency can be displayed by pressing the  key. From Remote, the output frequency can be queried with the `FREQ_ABS?` command, and the reference frequency can be queried with the `FREQ_BASE?` command.

Relative mode may not be enabled or disabled while sweep is active. See Section 4E, "Sweep" for more information.

SYNTAX:

	FRONT PANEL	REMOTE
Turn Relative Frequency Off	<input type="button" value="SPCL"/> <input type="button" value="2"/> <input type="button" value="0"/>	FREQ_REL OFF
Turn Relative Frequency On	<input type="button" value="SPCL"/> <input type="button" value="2"/> <input type="button" value="1"/>	FREQ_REL ON



## EXTERNAL FREQUENCY REFERENCE

4A-5.

The 6080A/AN normally operates on a 10-MHz internal reference oscillator. However, if desired, the signal generator can be operated on an external reference by setting the rear panel REF INT/EXT switch to EXT and connecting the external reference to the rear panel REF IN connector. The standard external reference frequency is 10 MHz.

An external reference frequency other than 10 MHz (specifically, 1, 2, or 5 MHz) can also be selected. The default alternate reference frequency is 5 MHz. See the 6080A/AN Service Manual for setting the 6080A/AN to use a 1- or 2- MHz reference frequency.

To configure the 6080A/AN from the front panel to use an external reference frequency other than 10 MHz, a Special Function command must be used. From Remote, the EXTREF\_FREQ command must be used. This configuration is in effect whenever the rear panel REF INT/EXT switch is set to EXT.

SYNTAX:

	FRONT PANEL	REMOTE
Select Standard (10MHz) External Reference Frequency	<input type="button" value="SPCL"/> <input type="button" value="7"/> <input type="button" value="6"/> <input type="button" value="0"/>	EXTREF_FREQ STD
Select Alternate External Reference Frequency	<input type="button" value="SPCL"/> <input type="button" value="7"/> <input type="button" value="6"/> <input type="button" value="1"/>	EXTREF_FREQ ALT

## RF FREQUENCY BANDS

4A-6.

All 6080A/AN RF frequencies are synthesized from a fundamental frequency in the range of 480 to 1056 MHz. This fundamental frequency is divided or heterodyned to produce the programmed output frequency. The frequency bands of the 6080A/AN are shown in Table 4A-1.

Table 4A-1. 6080A/AN Frequency Bands

TYPICAL BAND DESIGNATION	TYPICAL FREQUENCY RANGE (MHz)	SPECIFIED FREQUENCY RANGE (MHz)	DIVIDE RATIO
.01-15	.01 - 14.999999	.5 - 14.999999	Het
15-32	15 - 31.999999	15 - 31.999999	32
32-64	32 - 63.999999	32 - 63.999999	16
64-128	64 - 127.999999	64 - 127.999999	8
128-256	128 - 255.999999	128 - 255.999999	4
256-512	256 - 511.999999	256 - 511.999999	2
512-1056	512 - 1056.000000	512 - 1024.000000	1



## Section 4B

# RF Amplitude

### INTRODUCTION

**4B-1.**

Section 4B describes the procedures for programming the RF amplitude and the associated parameters of RF amplitude.

### RF AMPLITUDE ENTRY

**4B-2.**

The RF amplitude can be controlled with the FUNCTION-DATA-UNIT entry sequence. The amplitude display is fixed point for dBm and dB units and is floating point for voltage units. The selected unit is retained until a numeric entry is terminated with the alternate unit, the display units are converted (refer to the heading "RF Amplitude Units Conversion" in this Section), or an alternate dB unit is selected by Special Function (refer to the heading "Alternate dB Reference Units Selection" in this Section). Pressing the AMPL function key moves the bright digit to the AMPLITUDE display field and places the 6080A/AN in the RF Amplitude entry mode.

RF AMPLITUDE

RANGE	RESOLUTION
-147 to +20 dBm 10 nV to 2.24 V	0.1 dBm 3 digits

SYNTAX:

AMPL -- Numeric Data -- 
 dB(m)  
MHz|V  
kHz|mV  
Hz|μV

EXAMPLE: Set Amplitude to -7.5 dBm.

FRONT PANEL: AMPL - 7 . 5 dB(m)

REMOTE: AMPL -7.5 DBM

## RF AMPLITUDE UNITS CONVERSION

4B-3.

Conversion of a displayed RF amplitude quantity from dBm units to voltage units or from voltage units to dBm units is performed by selecting the Amplitude function, then pressing the desired unit key. The output of the 6080A/AN does not change during these operations. The display units remain in effect until a numeric entry is terminated with an alternate unit or the display units are converted by reversing the procedure.

AMPLITUDE UNITS CONVERSION:

$$V = 10^{(dBm - 13.0)/20.0}$$

$$dBm = 13.0 + 20.0 \log_{10}(V)$$

SYNTAX:

TO CONVERT	FRONT PANEL	REMOTE
dBm to Volts	<input type="button" value="AMPL"/> <input type="button" value="MHzV"/>	AMPL_UNITS V
Volts to dBm	<input type="button" value="AMPL"/> <input type="button" value="dB(m)"/>	AMPL_UNITS DBM

## ALTERNATE DB REFERENCE UNITS SELECTION

4B-4.

If the RF amplitude is displayed as a dBm quantity, alternate units of dBmV, dB $\mu$ V, or dBf may be selected. Selection of an alternate dB reference does not change the output of the 6080A/AN. The selected alternate units are retained when changing to or from voltage units, and remain in effect for any Amplitude entry terminated with the  unit key.

To select an alternate dB reference unit from the front panel, a Special Function command must be used. To select an alternate amplitude unit from Remote, the alternate amplitude unit is specified as the unit terminator for the AMPL command. See Section 5, "Remote Operation" for more information.

ALTERNATE AMPLITUDE UNITS:

$$\begin{aligned} dBmV &= dBm + 47.0 \\ dB V &= dBm + 107.0 \\ dBf &= dBm + 120.0 \end{aligned}$$

SYNTAX:

	FRONT PANEL	REMOTE
Select dBm Units	<input type="button" value="SPCL"/> <input type="button" value="8"/> <input type="button" value="4"/> <input type="button" value="0"/>	AMPL <numeric value> DBM
Select dBmV Units	<input type="button" value="SPCL"/> <input type="button" value="8"/> <input type="button" value="4"/> <input type="button" value="1"/>	AMPL <numeric value> DBMV
Select dB $\mu$ V Units	<input type="button" value="SPCL"/> <input type="button" value="8"/> <input type="button" value="4"/> <input type="button" value="2"/>	AMPL <numeric value> DBUV
Select dBf Units	<input type="button" value="SPCL"/> <input type="button" value="8"/> <input type="button" value="4"/> <input type="button" value="3"/>	AMPL <numeric value> DBF

**UNTERMINATED OUTPUT (EMF) MODE**

**4B-5.**

When enabled, unterminated output mode (EMF units) causes amplitude values to be doubled for voltage units, or offset by 6 dB for dBmV or dBμV units. This includes the displayed amplitude, the base amplitude (if the relative amplitude mode is on), the amplitude sweep increment (if in volts), and the amplitude sweep width (if in volts). This also includes all limits to the amplitude values. The unterminated output mode has no effect if the displayed quantity has units of dBm or dBf.

To select the Unterminated Output Display mode from the front panel, a Special Function command must be used. To select the mode from Remote, the AMPL\_EMFOUT command is used.

Enabling this mode has no effect on the 6080A/AN output. The EMF units are retained when changing to or from voltage units, and remain in effect for any Amplitude entry based on a voltage unit.

Disabling this mode may change the 6080A/AN output since resolution may be lost. For example, an RF amplitude of 201 mV programmed when in the unterminated output mode will be converted to 100 mV, not 100.5 mV when the mode is disabled.

**EMF UNITS CONVERSION:**

$$\begin{aligned} \text{EMF dBmV} &= \text{dBmV} + 6 \text{ dBmV} \\ \text{EMF dB}\mu\text{V} &= \text{dB V} + 6 \text{ dB V} \\ \text{EMF V} &= 2 * \text{V} \end{aligned}$$

**SYNTAX:**

	FRONT PANEL	REMOTE
Normal Amplitude Display Mode	<input type="button" value="SPCL"/> <input type="button" value="8"/> <input type="button" value="5"/> <input type="button" value="0"/>	AMPL_EMFOUT OFF
Unterminated Output Display Mode	<input type="button" value="SPCL"/> <input type="button" value="8"/> <input type="button" value="5"/> <input type="button" value="1"/>	AMPL_EMFOUT ON

## RF AMPLITUDE STEP ENTRY

4B-6.

The RF amplitude step size can be selected for entry by pressing the **AMPL** key, followed by the **STEP** key. As long as the **STEP** key is pressed, the step size is displayed. Upon entering a new step size, the value is held momentarily in the AMPLITUDE display field. Step Increment/Decrement operations are rejected unless the units of the amplitude and amplitude step match.

Note that 0.01 dB resolution is available for amplitude step sizes less than 20.0 dB, even though the RF amplitude is always displayed with 0.1 dB resolution. In the event that a step size with 0.01 dB resolution is selected, stepping the amplitude up or down may cause the display to become inconsistent with the actual amplitude. Parameter entry of a new RF amplitude will always zero the 0.01 dB digit; however, bright-digit edit operations retain the 0.01 dB resolution.

RF AMPLITUDE STEP SIZE	
RANGE	RESOLUTION
0.00 to 19.99 dB	0.01 dB
20.0 to 167.0 dB	0.1 dB
0 V to 2.24 V	3 digits

SYNTAX:

**AMPL** **STEP** -- Numeric Data -- **dB(m)**  
**MHz|V**  
**kHz|mV**  
**Hz|μV**

EXAMPLE: Set Amplitude Step Size to 6 dB.

FRONT PANEL: **AMPL** **STEP** **6** **dB(m)**

REMOTE: AMPL\_STEP 6 DB

## RF AMPLITUDE RELATIVE MODE

4B-7.

The RF Amplitude Relative Mode is useful for establishing a reference amplitude and then changing the output relative to that reference. Setting a reference is done by programming the RF amplitude to the desired value and then enabling the relative mode using a Special Function command from the front panel, or with the AMPL\_REL command from Remote. This causes the REL annunciator to light in the AMPLITUDE display field and the displayed value to become zero. The 6080A/AN output does not change during this operation. In the relative mode, the usual means of parameter modification may be used: Function Entry, Bright-Digit Edit, or Step Increment/Decrement.

In the relative amplitude mode, the output amplitude is the sum of the reference and the displayed amplitude when the reference and the displayed quantities have the same units. The output amplitude may be displayed by pressing the **AMPL** key. From Remote, the output amplitude can be queried with the AMPL\_ABS? command and the reference amplitude can be queried with the AMPL\_BASE? command.

Note that a reference amplitude having dBm, dBmV, dB $\mu$ V, or dBf units will be converted to a dB (ratio) value, so that the displayed value retains the units of the reference; the output is the displayed value scaled by the reference value. With mixed units (voltage and dB), the output amplitude is the voltage value scaled by the dB value. With voltage units, the output is the sum of the reference and the displayed values. Table 4B-1 illustrates the allowed combinations of reference and displayed amplitude, and shows how the amplitude values are interpreted with the relative amplitude mode enabled.

Relative mode may not be enabled or disabled while sweep is active. See Section 4E, "Sweep" for more information.

**SYNTAX:**

	FRONT PANEL	REMOTE
Disable Relative Amplitude	<input type="button" value="SPCL"/> <input type="button" value="3"/> <input type="button" value="0"/>	AMPL_REL OFF
Enable Relative Amplitude	<input type="button" value="SPCL"/> <input type="button" value="3"/> <input type="button" value="1"/>	AMPL_REL ON

**EXAMPLE:** Compensate for external gain or loss. A +10.0 dB gain amplifier is connected to the output of the 6080A/AN. Program the 6080A/AN to displayed the boosted output level using Relative Amplitude.

**FRONT PANEL:** Press the following keys to program the 6080A/AN to -10 dBm. The output of the amplifier is 0.0 dBm

Press the following keys to select Relative Amplitude. The 6080A/AN display now reflects the amplifier output (0.0 dBm).

**REMOTE:** AMPL 10.0 DBM; AMPL\_REL ON

**Table 4B-1. Relative Amplitude Unit Combinations**

AMPLITUDE WHEN RELATIVE MODE ENABLED	REFERENCE AMPLITUDE UNITS	DISPLAYED AMPLITUDE UNITS	OUTPUT AMPLITUDE ( <input type="button" value="AMPL"/> PRESSED)
dBm	dB	dBm	dBm (displayed) + dB (reference)
dBmV	dB	dBmV	dBmV (displayed) + dB (reference)
dB $\mu$ V	dB	dB $\mu$ V	dB $\mu$ V (displayed) + dB (reference)
dBf	dB	dBf	dBf (displayed) + dB (reference)
dBxx*	dB	voltage	voltage (displayed) x dB (reference)
voltage	voltage	dB	voltage (referenced) x dB (displayed)**
voltage	voltage	voltage	voltage (displayed) + V (reference)**

\* Any dB-based units (i.e. dBm, dB $\mu$ V, dBmV, dBf).  
 \*\* Units conversion of the displayed amplitude is not allowed when the reference amplitude has Voltage units, since an absolute quantity (Volts) cannot be converted to a ratio (dB).

**RF OUTPUT ON/OFF**

**4B-8.**

The RF output of the 6080A/AN is controlled using the RF OUTPUT  ON/OFF key from the front panel and the RFOUT command from Remote. Note that turning the RF Output on resets the Reverse Power Protection (RPP) circuitry if it has been tripped.

Pressing the RF OUTPUT  ON/OFF key will alternately turn the output off and on. When the RF output is off, the RF OFF annunciator is lit. The amplitude setting when the RF is turned off is restored when the output is turned on again. The displayed amplitude is not changed when the output is turned off.

SYNTAX:

	FRONT PANEL	REMOTE
Turn On RF Output (RF OFF annunciator on)	RF OUTPUT <input type="checkbox"/> ON/OFF	RFOUT ON
Turn Off RF Output (RF OFF annunciator off)	RF OUTPUT <input type="checkbox"/> ON/OFF	RFOUT OFF

**RF AMPLITUDE BANDS**

**4B-9.**

Amplitude settings for the 6080A/AN are achieved by cascading the RF output through a series of attenuators for coarse control and through a DAC for vernier control. The attenuator series consists of a single 6-dB section, a single 12-dB section, and five 24-dB sections. When Amplitude Modulation (AM) is enabled, the amplitude band switch points are shifted down by 3 dB. Table 4B-2 depicts the amplitude band divisions of the 6080A/AN in dBm units.

Table 4B-2 RF Amplitude Bands

AMPLITUDE IN dBm			
AM OFF		AM ON	
+7.0	+20.0	+4.0	+20.0
+1.0	+6.9	-2.0	+3.9
-5.0	+0.9	-8.0	-2.1
-11.0	-5.1	-14.0	-8.1
-17.0	-11.1	-20.0	-14.1
-23.1	-17.1	-26.1	-20.1
-29.1	-23.2	-32.1	-26.2
-35.1	-29.2	-38.1	-32.2
-41.1	-35.2	-44.1	-38.2
-47.1	-41.2	-50.1	-44.2
-53.2	-47.2	-56.2	-50.2
-59.2	-53.3	-62.2	-56.3
-65.2	-59.3	-67.2	-62.3
-71.2	-65.3	-73.2	-68.3
-77.2	-71.3	-80.3	-74.3



Table 4B-2 RF Amplitude Bands (cont)

AMPLITUDE IN dBM			
AM OFF		AM ON	
-83.3	-77.3	-86.3	-80.4
-89.3	-83.4	-92.3	-86.4
-95.3	-89.4	-98.3	-92.4
-101.3	-95.4	-104.4	-98.4
-107.4	-101.4	-110.4	-104.5
-113.4	-107.5	-116.4	-110.5
-119.4	-113.5	-122.4	-116.5
-125.4	-119.5	-128.4	-122.5
-147.0	-125.5	-147.0	-128.5

**RF AMPLITUDE FIXED-RANGE MODE**

**4B-10.**

When enabled, Amplitude Fixed-Range mode fixes the setting of the attenuators at the given output level. This allows monotonic and nontransient level control over a limited range around those levels where the attenuators are normally reranged.

Fixed-range mode is enabled using a Special Function command from the front panel, or with the AMPL\_RANGE command from Remote. The SPCL annunciator is lit when fixed-range mode is enabled. Fixed-range level control remains in effect only during Bright-Digit Edit of the AMPLITUDE display field. Other methods of changing the output cause the attenuators to rerange if necessary. Changing the RF frequency, initiating an RF amplitude sweep, or enabling/disabling AM will also cause the attenuators to rerange.

The level vernier in fixed-range mode has a specified accuracy range of 12 dB around the point at which fixed-range mode is enabled. If an attempt is made to edit the amplitude value beyond the range of the vernier, the STATUS annunciator will flash, and the output level will not be guaranteed.

SYNTAX:

	FRONT PANEL	REMOTE
Disable Fixed-Range	SPCL 5 0	AMPL_RANGE NORMAL
Enable Fixed-Range	SPCL 5 1	AMPL_RANGE FIXED

EXAMPLE: Set the 6080A/AN for monotonic and nontransient amplitude control (Bright-Digit Edit only) over the range of the vernier level control below 0.25V.

FRONT PANEL: AMPL • 2 5 MHz/V SPCL 5 1

REMOTE: AMPL 0.25 V ; AMPL\_RANGE FIXED

## ALTERNATE OUTPUT COMPENSATION MODES

4B-11.

Alternate output compensation modes are available on the 6080A/AN. Normally, a factory-generated set of data which characterizes the output circuitry is applied, and a factory-generated set of data which characterizes the attenuators is applied. It is possible to configure the 6080A/AN to apply the output circuitry compensation data only (no attenuator compensation) to the output, or to apply no compensation data to the output. Selecting a compensation mode is done using a Special Function command from the front panel, or with the AMPL\_COMP command from Remote. The SPCL annunciator is lit when an alternate compensation mode is selected.

### SYNTAX:

	FRONT PANEL	REMOTE
Apply All Compensation Data	SPCL 9 2 0	AMPL_COMP ALL
Apply No Compensation Data*	SPCL 9 2 1	AMPL_COMP NONE
Apply Output Compensation Only	SPCL 9 2 2	AMPL_COMP OUTPUT

\* NOTE: Also disables Level Calibration

## SELECTING ALTERNATE OUTPUT COMPENSATION DATA

4B-12.

The 6080A/AN has provision for user-definable output (output circuitry) compensation data. It is possible to characterize the 6080A/AN when the RF output is connected through a lengthy or lossy path and store this data. The method for generating this data is described in the 6080A/AN Service Manual. Once an alternate set has been loaded, the alternate compensation data can be selected for use using a Special Function command from the front panel, or with the AMPL\_CMPDAT command from Remote. The SPCL annunciator is lit when alternate compensation data are selected.

### SYNTAX:

	FRONT PANEL	REMOTE
Apply Standard Output Compensation Data	SPCL 9 3 0	AMPL_CMPDAT STD
Apply Alternate Output* Compensation Data	SPCL 9 3 1	AMPL_CMPDAT ALT

\* NOTE: This compensation data is only applied to the Output Circuitry.

# Section 4C

## Modulation

### INTRODUCTION

4C-1.

The 6080A/AN Signal Generator offers four modulation capabilities:

- Amplitude modulation (AM)
- Frequency modulation (FM)
- Phase modulation ( $\phi$ M)
- Pulse modulation (□) (square wave)

The MODULATION ON/OFF keys are used to enable and disable one or more types of modulation from internal and external sources. Each modulation key is a toggle on/off type. Annunciators in the MODULATION display field indicate the enabled modulation types.

Various combinations of AM, FM/ $\phi$ M, and pulse modulation may be enabled in either internal or external (or both) modes. Some restrictions exist for certain combinations:

- FM and  $\phi$ M are always mutually exclusive
- External AC and DC modes of each modulation form are mutually exclusive.

It is easier to understand by considering AM, FM/ $\phi$ M, and pulse modulation as three separate groups, where FM and  $\phi$ M are mutually exclusive members of a single group. While interactions and exclusions exist within each group, there are no interactions between groups. In other words, no combination of AM on/off modes ever interacts with FM/ $\phi$ M on/off modes, or pulse modulation on/off modes.

The MODULATION display field is shared by amplitude modulation depth, frequency/phase modulation deviation, modulation frequency, and modulation level. Since there is only one modulation display, the displayed modulation parameter is determined by the last modulation FUNCTION key pressed.

### MODULATION, AM

4C-2.

Amplitude modulation (AM) depth is displayed in the 6080A/AN modulation display field with 0.1% of resolution. The AM depth is displayed with “%” units.

Note that internal AM can be combined with external AC-coupled AM (ACAM) or external DC-coupled AM (DCAM). However, external ACAM and external DCAM are mutually exclusive. Enabling external ACAM while external DCAM is enabled turns off external DCAM, and vice versa.

### AM Depth and AM Depth Step Size Entry

4C-3.

The AM depth and AM depth step size are controlled using the FUNCTION-DATA-UNIT entry sequence. Pressing the **AM** function key causes the MODULATION display field to display the AM depth, moves the bright digit to the MODULATION display field and places the 6080A/AN in the AM depth entry mode. Entry or modification of the AM depth value does not change the 6080A/AN output unless AM is enabled. The AM depth step size is selected for entry by pressing the **STEP** key after selecting the AM function.

AM DEPTH	
RANGE	RESOLUTION
0 to 99.9%	0.1%

AM DEPTH STEP SIZE	
RANGE	RESOLUTION
0 to 99.9%	0.1%

SYNTAX:

Set AM Depth

**AM** -- numeric data -- **%rad**

Select AM Depth Step Size

**AM** **STEP** -- numeric data -- **%rad**

EXAMPLE 1: Set AM depth to 23.5%

FRONT PANEL: **AM** **2** **3** **.** **5** **%rad**

REMOTE: AM 23.5 PCT



EXAMPLE 2: Set AM depth step size to 1.0%

FRONT PANEL: **AM** **STEP** **1** **%rad**

REMOTE: AM\_STEP 1.0 PCT



### Internal AM

4C-4.

Internal AM is enabled by pressing the  key from the front panel, or using the INT\_AM ON command from Remote. The INT AM annunciator is lit when Internal AM is enabled. With Internal AM enabled, the internal modulation oscillator modulates the RF signal to the specified AM Depth at the modulation frequency rate. This rate may be viewed by pressing . Pressing the  key again disables Internal AM, as does the INT\_AM OFF command from Remote.

### External AM



4C-5.

External AC-coupled AM (ACAM) is enabled by pressing the  key from the front panel, or with the EXTAC\_AM ON command from Remote. The EXT AM annunciator is lit when External AM is enabled. When external AM is enabled, the modulating signal is applied through the front panel external AM input connector. Pressing the  key again disables External AM, as does the EXTAC\_AM OFF command from Remote.

External AM uses a 1-volt peak input signal. Two annunciators on the front panel give indications of when the external ACAM modulation signal is outside the range of 2% of 1 volt. These annunciators are lit only when external ACAM is enabled and are not active when external DCAM is enabled. If the signal is greater than 1.02 volt, the AM HI annunciator is lit. If the signal is less than 0.98 volt, the AM LO annunciator is lit.

### External AM, DC Coupled

4C-6.

External DC-coupled AM (DCAM) is enabled by pressing the  key from the front panel, or using with the EXTDC\_AM ON command from Remote. The EXT DC AM annunciator is lit when External AM is enabled. When external AM is enabled, the modulating signal is applied through the front panel external AM input connector. External AM is normalized for a 1-volt peak input signal. Pressing the  key again disables External DC AM, as does the EXTDC\_AM OFF command from Remote.

### MODULATION, FM/ $\phi$ M

4C-7.

Frequency modulation (FM) deviation and phase modulation ( $\phi$ M) deviation are displayed in the 6080A/AN front panel MODULATION display field with three digits of resolution. FM is displayed with MHz DEV, kHz DEV, or Hz DEV units, and  $\phi$ M is displayed with rad units.

$\phi$ M entries and modifications are processed internally as FM after the  $\phi$ M deviation is converted to an equivalent FM deviation. The modulation circuitry is configured to maintain this relationship over the range of allowed modulation frequencies and deviations. Because of this direct relationship between FM and  $\phi$ M, this section focuses on FM programming, with references to  $\phi$ M where appropriate.

#### NOTE

*FM and  $\phi$ M are always mutually exclusive. For FM, external ACFM and external DCFM are mutually exclusive. For  $\phi$ M, external AC $\phi$ M and external DC $\phi$ M are mutually exclusive. Enabling external ACFM while external DCFM is enabled, turns off external DCFM, and vice versa. The same holds true for  $\phi$ M.*

### FM/ $\phi$ M Deviation and FM/ $\phi$ M Step Size Entry

4C-8.

The FM/ $\phi$ M deviation and FM/ $\phi$ M deviation step size are controlled using the FUNCTION-DATA-UNIT entry sequence. Pressing the FM/ $\phi$ M deviation function key **FM/ $\phi$ M** causes the MODULATION display field to display the current FM/ $\phi$ M deviation, moves the bright digit to the MODULATION display field, and places the 6080A/AN in the FM/ $\phi$ M deviation entry mode. Entry or modification of the FM/ $\phi$ M deviation value does not change the 6080A/AN output unless FM/ $\phi$ M is enabled.

The FM/ $\phi$ M deviation step size is selected for entry by pressing the **STEP** key after selecting the FM/ $\phi$ M function. Although the FM/ $\phi$ M deviation and FM/ $\phi$ M deviation step size may have different units, Step Increment and Decrement operations are rejected unless the units are consistent.

FM/ $\phi$ M DEVIATION		
	RANGE	RESOLUTION
FM	0 to 4.0 MHz	3 digits
$\phi$ M	0 to 400 rad	3 digits

FM/ $\phi$ M DEVIATION STEP SIZE		
	RANGE	RESOLUTION
FM	0 to 4.0 MHz	3 digits
$\phi$ M	0 to 400 rad	3 digits

SYNTAX:

Set FM Deviation

**FM/ $\phi$ M** -- numeric data -- **MHz|V**  
**kHz|mV**  
**Hz| $\mu$ V**

Set  $\phi$ M Deviation

**FM/ $\phi$ M** -- numeric data -- **%|rad**

Select FM deviation step size

**FM/ $\phi$ M** **STEP** -- numeric data -- **MHz|V**  
**kHz|mV**  
**Hz| $\mu$ V**

Select  $\phi$ M deviation step size

**FM/ $\phi$ M** **STEP** -- numeric data -- **%|rad**

EXAMPLE 1: Set FM deviation to 50 kHz

FRONT PANEL: **FM/ $\phi$ M** **5** **0** **kHz|mV**

REMOTE: FM 50 KHZ

EXAMPLE 2: Set FM deviation step size to 500 Hz

FRONT PANEL: **FM/ $\phi$ M** **STEP** **5** **0** **0** **Hz| $\mu$ V**

REMOTE: FM\_STEP 500 HZ

The maximum FM/ϕM deviation allowed when FM or ϕM is enabled depends on the RF frequency. Deviations up to 4 MHz or 400 radians may be entered regardless of the output frequency; however, the STATUS annunciator is flashed if FM/ϕM modulation is enabled and the limits specified in Table 4C-1 are exceeded.

Table 4C-1. FM/ϕM Deviation Limits (FM/ϕM Enabled)

TYPICAL FREQUENCY BAND	MAXIMUM FM DEVIATION	MAXIMUM ϕM DEVIATION
.01 - 15	500 kHz	50.0 rad
15 - 32	125 kHz	12.5 rad
32 - 64	250 kHz	25.0 rad
64 - 128	500 kHz	50.0 rad
128 - 256	1.0 MHz	100 rad
256 - 512	2.0 MHz	200 rad
512 - 1056	4.0 MHz	400 rad

**FM/ϕM Units Conversion**

**4C-9.**

When converting from FM deviation to ϕM deviation and vice versa, the output of the 6080A/AN does not change. However, the programmed modulation frequency must be taken into account, specifically:

$$\text{FM deviation (Hz)} = \phi\text{M deviation (rad)} * \text{Modulation Frequency (Hz)}$$

$$\phi\text{M deviation (rad)} = \text{FM deviation (Hz)} / \text{Modulation Frequency (Hz)}$$

The Mod Frequency used in these equations is always that of the internal modulation oscillator. Note that certain combinations of modulation frequency and the FM deviation or ϕM deviation may not be converted into the alternate units if the resulting deviation is outside the range allowed for those units.



Since the frequency of an external modulation source cannot be determined, FM/ϕM units conversion is rejected if external FM or ϕM is enabled.

SYNTAX:

TO CONVERT	FRONT PANEL	REMOTE
FM to ϕM	FM ϕM    % rad	FM_UNITS RAD
ϕM to FM	FM ϕM    MHz V kHz mV Hz µV	FM_UNITS HZ



### Internal FM/ $\phi$ M

4C-10.

Internal FM/ $\phi$ M is enabled by pressing the  key from the front panel or with the INT\_FM ON command from Remote. The unit specified for the FM deviation determines if the INT FM or INT  $\phi$ M annunciator is lit when Internal FM/ $\phi$ M is enabled. With Internal FM/ $\phi$ M enabled, the internal modulation oscillator modulates the RF to the specified FM deviation or  $\phi$ M phase angle at the modulation frequency rate. This rate may be viewed by pressing . Pressing the  key again disables Internal FM/ $\phi$ M, as does the INT\_FM OFF command from Remote.

### External FM/ $\phi$ M



4C-11.

External AC-coupled FM/ $\phi$ M (ACFM) is enabled by pressing the  key from the front panel, or with the EXTAC\_FM ON command from Remote. The EXT FM annunciator is lit when External FM is enabled, and the EXT  $\phi$ M annunciator is lit when External  $\phi$ M is enabled. When either is enabled, the modulating signal is applied through the front panel external FM/ $\phi$ M input connector. Pressing the  key again disables External FM/ $\phi$ M, as does the EXTAC\_FM OFF command from Remote.

External FM/ $\phi$ M uses a 1-volt peak input signal. Two annunciators on the front panel give indications of when the external ACFM or AC $\phi$ M modulation signal is outside the range of 2% of 1 volt. These annunciators are only lit when external ACFM or AC $\phi$ M is enabled and are not active when external DCFM or DC $\phi$ M is enabled. If the signal is more than 1.02 volt, the FM HI annunciator is lit. If the signal is less than 0.98 volt, the FM LO annunciator is lit.

### External DCFM

4C-12.

External DCFM is enabled by pressing the  key from the front panel, or with the EXTDC\_FM ON command from Remote. The EXT DC FM annunciator is lit when External FM is enabled, and the EXT DC  $\phi$ M annunciator is lit when External DC  $\phi$ M is enabled. When either is enabled the modulating signal is applied through the front panel external FM/ $\phi$ M input connector. External FM/ $\phi$ M is normalized for a 1-volt peak input signal. Pressing the  key again disables External FM/ $\phi$ M, as does using the EXTDC\_FM OFF command from Remote.

The external DCFM mode allows the RF signal to be frequency modulated by DC or by slowly varying AC rates by an input signal connected to the front panel FM/ $\phi$ M modulation input connector. Enabling DCFM selects the DC coupled path from the external FM/ $\phi$ M connector and forces the FM modulation circuitry to search for a correction voltage which causes the FM loop to lock. The FM loop is operated unlocked, but remains locked for the selected combination of FM Deviation and RF frequency, because of this voltage correction.

This search for the FM loop correction voltage is called a DCFM “cal cycle”. The time required to perform a DCFM cal cycle is determined by the selected FM band (see Section 4C-13). In most cases, the DCFM cal cycle completes in 0.5 seconds. However, if FM deviation in excess of 250 kHz is selected, the DCFM cal cycle can take up to 5 seconds. Once DCFM has been enabled, the message “PAUSE” appears in the FREQUENCY display field. When the hardware has settled, the display returns to its normal state.

While DCFM is enabled, the RF frequency will drift with time. To remove the offset caused by this drift, a DCFM cal cycle should be performed as necessary. To force a DCFM cal cycle to occur, ACFM should be enabled (by pressing the  key), followed by re-enabling DCFM.



External DC  $\phi$ M is identical to external AC  $\phi$ M except that the external FM/ $\phi$ M modulation input is DC coupled. Pressing the EXT DC  
FM $\phi$ M key while the FM/ $\phi$ M display shows  $\phi$ M in radians units, enables the DC coupled path from the external FM/ $\phi$ M input connector, and enables the FM/ $\phi$ M circuitry programmed in the phase modulation mode. The external DC $\phi$ M mode is entirely different from external DCFM, as the FM oscillator loop remains locked.

**FM Bands**

**4C-13.**

The interdependence between RF frequency bands and FM bands is summarized in Tables 4C-2 and 4C-3. Table 4C-2 shows the FM band limits for normal FM mode. Table 4C-3 shows these limits when Low-Distortion FM is enabled. Each table is a two-dimensional matrix: the column entries represent RF frequency bands, and the row entries represent each FM band. Each box lists the FM deviations that correspond to the upper and lower limits for that intersection of FM band and RF frequency band.

**Table 4C-2. FM Band Limits**

FREQ BAND FM BAND	512-1056	256-512	128-256	64-128 and .01-15	32-64	15-32
6	4.00 MHz 1.01 MHz	2.00 MHz 501 kHz	1.00 MHz 251 kHz	500 kHz 126 kHz	250 kHz 62.6 kHz	125 kHz 31.3 kHz
5	1.00 MHz 251 kHz	500 kHz 126 kHz	250 kHz 62.6 kHz	125 kHz 31.3 kHz	62.5 kHz 15.7 kHz	31.2 kHz 7.82 kHz
4	250 kHz 62.6 kHz	125 kHz 31.3 kHz	62.5 kHz 15.7 kHz	31.2 kHz 7.82 kHz	15.6 kHz 3.91 kHz	7.81 kHz 1.96 kHz
3	62.5 kHz 15.7 kHz	31.2 kHz 7.82 kHz	15.6 kHz 3.91 kHz	7.81 kHz 1.96 kHz	3.90 kHz 977 Hz	1.95 kHz 489 Hz
2	15.6 kHz 3.91 kHz	7.81 kHz 1.96 kHz	3.90 kHz 977 Hz	1.95 kHz 489 Hz	976 Hz 245 Hz	488 Hz 123 Hz
1	3.90 kHz 0 Hz	1.95 kHz 0 Hz	976 Hz 0 Hz	488 Hz 0 Hz	244 Hz 0 Hz	122 Hz 0 Hz
0	CW MODE					

**FRONT PANEL OPERATION  
MODULATION**

**Table 4C-3. FM Band Limits - Low Distortion Mode**

<b>FREQ BAND / FM BAND</b>	<b>512-1056</b>	<b>256-512</b>	<b>128-256</b>	<b>64-128 and .01-15</b>	<b>32-64</b>	<b>15-32</b>
<b>6</b>	4.00 MHz 1.01 MHz	2.00 MHz 501 kHz	1.00 MHz 251 kHz	500 kHz 126 kHz	250 kHz 62.6 kHz	125 kHz 31.3 kHz
<b>5</b>	1.00 MHz 251 kHz	500 kHz 126 kHz	250 kHz 62.6 kHz	125 kHz 31.3 kHz	62.5 kHz 15.7 kHz	31.2 kHz 7.82 kHz
<b>4</b>	250 kHz 28.1 kHz	125 kHz 14.1 kHz	62.5 kHz 7.01 kHz	31.2 kHz 3.51 kHz	15.6 kHz 1.76 kHz	7.81 kHz 876 Hz
<b>3</b>	28.0 kHz 15.7 kHz	14.0 kHz 7.82 kHz	7.00 kHz 3.91 kHz	3.50 kHz 1.96 kHz	1.75 kHz 977 Hz	875 Hz 489 Hz
<b>2</b>	15.6 kHz 2.01 kHz	7.81 kHz 1.01 kHz	3.90 kHz 501 Hz	1.95 kHz 251 Hz	976 Hz 126 Hz	488 Hz 63 Hz
<b>1</b>	2.00 kHz 0 Hz	1.00 kHz 0 Hz	500 Hz 0 Hz	250 Hz 0 Hz	125 Hz 0 Hz	62 Hz 0 Hz
<b>0</b>	<b>CW MODE</b>					

**Low Distortion/Fixed-Range FM**

**4C-14.**

Two modes are available to modify or limit the ranging of the FM circuitry. These modes offer improved performance of the FM circuitry for certain applications. These modes are enabled using a Special Function command from the front panel, or with the FM\_RANGE command from Remote. Entering either of these modes lights the SPCL annunciator below the FREQUENCY display field.

In the normal operation mode, the optimal FM band is determined for the specified combination of RF frequency and FM deviation.

In FM Low Distortion mode, the total harmonic distortion is diminished, with a corresponding increase in phase noise. This mode provides the optimum phase noise-to-distortion performance at 3.5-kHz FM deviation at Mod Frequencies of 0.3 to 3 kHz.

In FM Fixed-Range mode, total harmonic distortion is improved over a wide range of FM deviation, with the lowest distortion near the lower end of each FM band. In this mode, it is possible to edit above or below the normal FM band limits since the normal FM autorange function is inhibited. The Fixed-Range mode locks to the FM band so that all subsequent adjustments made to the FM deviation and the RF frequency with the edit knob are processed without the auto-range. If an attempt is made to edit either of these values beyond the range limit, the STATUS annunciator flashes, and the value is constrained to the limit.

When FM Fixed-Range mode is enabled, FM deviation or step entries that map into FM ranges other than the current range will cause the FM circuitry to rerange. Fixed-Range mode remains in effect with the new FM range locked in. In addition, a change in the RF frequency can also force a FM rerange.

SYNTAX:

	FRONT PANEL	REMOTE
Normal FM Ranging Mode	SPCL 7 3 0	FM_RANGE NORMAL
Low Distortion FM Mode	SPCL 7 3 1	FM_RANGE LOWDISTORT
Fixed-Range FM Mode	SPCL 7 3 2	FM_RANGE FIXED

### Low Rate FM

4C-15.

Certain applications require FM at low modulation rates but cannot tolerate the shortcomings associated with operating in the DCFM mode when the FM loop is unlocked. When Low-Rate FM is enabled, lower modulation rates may be applied.

Low Rate FM mode is enabled with a Special Function command from the front panel, or with the LORATEFM command from Remote. Although the mode is enabled, the FM circuitry is not set to the low-rate configuration unless internal FM or external FM is also enabled. Enabling this function does not affect the circuitry if the 6080A/AN is programmed for phase modulation.

When the low-rate FM mode is enabled, the SPCL annunciator in the FREQUENCY display field is lit. The LO RATE annunciator in the MODULATION display field is lit when internal or external FM is enabled.

SYNTAX:

	FRONT PANEL	REMOTE
Turn Low Rate FM Off	SPCL 7 1 0	LORATEFM OFF
Turn Low Rate FM On	SPCL 7 1 1	LORATEFM ON

### High Rate $\phi$ M

4C-16.

The high-rate  $\phi$ M mode trades higher modulation rates (up to 100 kHz) for less phase modulation deviation. Up to 40 radians of phase deviation are allowed in this mode.

High Rate  $\phi$ M mode is enabled with a Special Function command from the front panel, or with the HIRATEPM command from Remote. When the high-rate  $\phi$ M mode is enabled, the SPCL annunciator in the FREQUENCY display field is lit.

SYNTAX:

	FRONT PANEL	REMOTE
Disable High Rate $\phi$ M	SPCL 7 2 0	HIRATEPM OFF
Enable High Rate $\phi$ M	SPCL 7 2 1	HIRATEPM ON



## MODULATION, PULSE

4C-17.

External and internal pulse modulation are supported in the 6080A/AN. Both internal and external pulse modulation may be enabled simultaneously. External pulse modulation input is always DC coupled. Any symmetric waveform can be used to drive the pulse modulation circuitry.

### External Pulse

4C-18.

External Pulse is enabled by pressing the  key from the front panel, or with the EXT\_PULSE ON command from Remote. The EXT  annunciator is lit when External Pulse is enabled. Pressing the  key again disables External Pulse Mode, as does the EXT\_PULSE OFF command from Remote.

External pulse modulation input is always DC coupled, and can be driven by a TTL compatible signal. External pulse modulation is triggered at a 1V threshold crossing; any modulating signal applied to the EXT  front panel connector causes full scale output when the input signal exceeds the threshold and full attenuation when the input signal is below the threshold.









### Internal Pulse

4C-19.

Internal Pulse is enabled with a Special Function command from the front panel, or with the INT\_PULSE command from Remote. The INT  annunciator is lit when Internal Pulse is enabled.

Internal Pulse mode is usable with any internal modulation oscillator waveform. A special mode of pulse modulation, with variable pulse width, is described in paragraph 4C-26 (“Internal Pulse Generator Mode”).

SYNTAX:

	FRONT PANEL	REMOTE
Turn Off Internal Pulse Modulation	   	INT_PULSE OFF
Turn On Internal Pulse Modulation	   	INT_PULSE ON

## INTERNAL MODULATION OSCILLATOR

4C-20.

The internal modulation oscillator digitally synthesizes one of three predetermined waveforms at a specified modulation frequency. In addition, it can be configured as a pulse generator where the pulse width and repetition rate are programmable. The synthesized modulation waveform is available at the front panel connector labeled MOD OUTPUT.

### Modulation Frequency Entry and Step Size Entry

4C-21.

The modulation frequency (Mod Frequency) is displayed in the 6080A/AN front panel MODULATION display field with three digits of resolution. The Mod Frequency is displayed with kHz or Hz units, with the MOD\_FREQ annunciator on.

Mod Frequency and the Mod Frequency Step Size are controlled using the FUNCTION-DATA-UNIT entry sequence. Pressing the **MOD FREQ** function key causes the MODULATION display field to display the Mod Frequency, moves the bright digit to the MODULATION display field and places the 6080A/AN in the Mod Frequency entry mode. Entry or modification of the Mod Frequency does not change the 6080A/AN output unless internal modulation is enabled. The Mod Frequency step size is selected for entry by pressing the **STEP** key after selecting the Mod Frequency function.

As a shortcut method, the **400/1000** key can be used to toggle the Mod Frequency between 400 and 1000 Hz. The MODULATION display field is updated to reflect 400 Hz or 1.00 kHz as the values are selected. This key is inactive when the front panel bright digit is turned off.

MODULATION FREQUENCY

RANGE	RESOLUTION
0.1 Hz to 200 kHz	3 digits

SYNTAX:

Modulation Frequency

**MOD FREQ** -- numeric data -- **MHz|V**  
**kHz|mV**  
**Hz| $\mu$ V**

Modulation Frequency Step Size

**MOD FREQ** **STEP** -- numeric data -- **MHz|V**  
**kHz|mV**  
**Hz| $\mu$ V**

EXAMPLE 1: Set Modulation Frequency to 19 kHz

FRONT PANEL: **MOD FREQ** **1** **9** **kHz|mV**

REMOTE: MODF 19 KHZ

EXAMPLE 2: Set Modulation Frequency Step Size to 1 kHz

FRONT PANEL: **MOD FREQ** **STEP** **1** **kHz|mV**

REMOTE: MODF\_STEP 1 KHZ

### Extended Resolution Modulation Frequency Entry

4C-22.

An extended resolution mode is available for entry of Mod Frequency. This mode is enabled with a Special Function command and allows the Mod Frequency to be input from the front panel with 0.1Hz resolution over its entire range. This resolution is always available from remote using the "MODF" command.

Entering    displays the current modulation frequency in the FREQUENCY display field with 0.1 Hz resolution followed by a question mark prompt which indicates that a new modulation frequency can be entered. If a new modulation frequency is entered in response to the prompt, it is rounded to 0.1 Hz resolution and the modulation oscillator circuitry is programmed accordingly. The new modulation frequency is displayed in the MODULATION display field. If it has more than three significant digits, it is rounded to three digits before it is displayed.

Mod Frequency entries are stored in two formats: with the displayed 3-digit resolution and with extended 0.1 Hz resolution. Every Mod Frequency or extended resolution Mod Frequency entry is stored in both formats. However, step, edit, store and recall operations operate on the displayed value only. Extended resolution Mod Frequency entries are temporary entries, in that any edit or step increment/decrement operations force the value back into normal resolution. Only Special Function 42 will display an extended entry with full resolution, and only if no intervening commands have truncated it.

SYNTAX:

-- Numeric Data--

### Modulation Level Entry and Step Size Entry

4C-23.

Modulation level refers to the peak level signal present at the front panel connector (labeled MOD OUTPUT), into a 600-ohm load. The modulation level (Mod Level) is displayed in the 6080A/AN front panel MODULATION display field with three digits of resolution. The Mod Level is displayed with V units, with the MOD LEVEL annunciator on.

The Mod Level and Mod Level step size are controlled using the FUNCTION-DATA-UNIT entry sequence. Pressing the  key causes the MODULATION display field to display the current Mod Level, moves the bright digit to the MODULATION display field, and places the 6080A/AN in the Mod Level entry mode. The Mod Level setting has no effect on the 6080A/AN RF output. The Mod Level step size is selected for entry by pressing the  key after selecting the Mod Level function.

MODULATION LEVEL

RANGE	RESOLUTION
0.0 to 4.00 V	3 digits

MODULATION LEVEL STEP SIZE

RANGE	RESOLUTION
0.0 to 4.00 V	3 digits

SYNTAX:

Modulation Level

-- numeric data --

Modulation Level Step Size

-- numeric data--

EXAMPLE 1: Set Modulation Level to 1.41 v

FRONT PANEL:

REMOTE: MODL 1.41 V

EXAMPLE 2: Set Modulation Level Step Size to 1 mV

FRONT PANEL:

REMOTE: MOD\_STEP 1 MV

**Modulation Output On/Off**

**4C-24.**

Output of the internal modulation oscillator signal through the MOD OUTPUT connector on the front panel may be enabled and disabled. Note that the internal modulation signal is normally output through this connector, even though all internal modulation is off. To disable output when internal modulation is turned off, a Special Function must be used from the front panel, or the MODOUT command must be used from Remote. Note that a modulation signal is present whenever any form of internal modulation is enabled. The SPCL annunciator is lit when the modulation output is disabled.

SYNTAX:

	FRONT PANEL	REMOTE
Turn Off Modulation Output	<input type="checkbox"/> SPCL <input type="checkbox"/> 4 <input type="checkbox"/> 1	MODOUT OFF
Turn On Modulation Output	<input type="checkbox"/> SPCL <input type="checkbox"/> 4 <input type="checkbox"/> 0	MODOUT ON

**Internal Modulation Waveform Selection**

**4C-25.**

The 6080A/AN internal modulation oscillator is capable of producing a variety of output waveforms. These waveforms are: sine wave, triangle wave, and square wave. The oscillator may also be configured as a variable width pulse generator. Only one of the waveforms, or the internal pulse generator mode can be enabled at any given time.

The selected waveform may be applied to the internal AM, internal FM, or internal pulse circuitry. Each modulation path (AM, FM, pulse) is controlled independently of the others.

This selection scheme allows any waveform to be applied to internal AM, internal FM, or internal pulse. In addition, multiple modulation paths (e.g., internal AM and internal FM) may be simultaneously enabled to use the selected waveform, although the resulting output may be of little use.

The SPCL annunciator is lit when an alternate modulation waveform is selected. The following Front Panel key sequences and Remote commands select the waveform of the modulation oscillator:

SYNTAX:

WAVEFORM	FRONT PANEL	REMOTE
Sine	<input type="checkbox"/> SPCL <input type="checkbox"/> 7 <input type="checkbox"/> 5 <input type="checkbox"/> 0	MOD_WAVE SINE
Triangle	<input type="checkbox"/> SPCL <input type="checkbox"/> 7 <input type="checkbox"/> 5 <input type="checkbox"/> 1	MOD_WAVE TRIANGLE
Square	<input type="checkbox"/> SPCL <input type="checkbox"/> 7 <input type="checkbox"/> 5 <input type="checkbox"/> 2	MOD_WAVE SQUARE



**Internal Pulse Generator Mode**

**4C-26.**

The internal modulation oscillator can be configured as a variable width pulse generator. When configured in this mode, the internal mod oscillator generates a free running pulse train. Triggering of this pulse train is not possible.

Selecting the pulse generator mode in conjunction with the internal pulse modulation path provides internal pulse modulation with variable duty cycle. Pulse periods in the range of 100 ms to 5  $\mu$ s are available by programming the Mod Frequency in the range from 10 Hz to 200 kHz. If a pulse period less than the pulse width is specified, the STATUS annunciator is flashed, and a pulse width that is 0.1  $\mu$ s less than the pulse period is substituted.

The pulse period is given priority over the pulse width. However, if a Mod Frequency is entered that would result in a pulse period less than the stored pulse width, the pulse width will be programmed to 0.1  $\mu$ s less than the pulse period.

Modulation frequencies less than 10 Hz (pulse periods greater than 100 ms) can be entered; however, the STATUS annunciator is flashed and the pulse period is programmed to 100 ms.

The internal pulse generator is enabled with a Special Function command from the front panel or with the MOD\_WAVE command from Remote.

SYNTAX:

	FRONT PANEL	REMOTE
Disable Internal Pulse Generator	<div style="display: flex; gap: 5px;"> <div style="border: 1px solid black; padding: 2px 5px;">SPCL</div> <div style="border: 1px solid black; padding: 2px 5px;">7</div> <div style="border: 1px solid black; padding: 2px 5px;">5</div> <div style="border: 1px solid black; padding: 2px 5px;">0</div> </div>	MOD_WAVE SINE
Enable Internal Pulse Generator	<div style="display: flex; gap: 5px;"> <div style="border: 1px solid black; padding: 2px 5px;">SPCL</div> <div style="border: 1px solid black; padding: 2px 5px;">7</div> <div style="border: 1px solid black; padding: 2px 5px;">5</div> <div style="border: 1px solid black; padding: 2px 5px;">8</div> </div>	MOD_WAVE PULSE

**Pulse Width Selection**

**4C-27.**

When the modulation oscillator is configured as a variable width pulse generator, any pulse width in the valid range may be entered using a Special Function command from the front panel or the PULSE\_WIDTH command from Remote.

The pulse width will be specified with 0.1  $\mu$ s resolution over its entire range of values. Entering     displays the current pulse width in the FREQUENCY display field with 0.1  $\mu$ s resolution followed by a question mark prompt which indicates that a new pulse width can be entered. The characters " $\mu$ S" are displayed in the AMPLITUDE display field to clarify that this is the pulse width entry even though it is displayed in the FREQUENCY display field. If the entered pulse width is longer than the pulse period (1/Mod Frequency), the STATUS annunciator is flashed, and the pulse width is set to 0.1  $\mu$ s less than the pulse period.

PULSE WIDTH	
RANGE	RESOLUTION
0.1 $\mu$ s to 100 ms	0.1 $\mu$ s

SYNTAX:

-- numeric data --

NOTE

The pulse width is always displayed with microsecond units. Pulse width entries are terminated with one of the following:

microsecond units =   
 millisecond units =   
 second units =

EXAMPLE: Program a pulse width of 100.0  $\mu$ s

FRONT PANEL: Enter

The current pulse width is displayed in the FREQUENCY display field with a question mark prompt.

100 000.0 ? S (current setting is 100000.0  $\mu$ s)

Enter     to program a 100 microsecond pulse width.

REMOTE: PULSE\_WIDTH 100 US

# Section 4D

## Memory

### ORGANIZATION OF 6080A/AN MEMORY

4D-1.

The 6080A/AN features non-volatile memory for storage and recall of instrument settings. Up to 50 full instrument settings can be saved and recalled through memory operations. Six different memory operations are allowed from the front panel:

- Recall of a memory location
- Store to a memory location
- Recall next memory location
- Recall previous memory location
- Store a single function parameter.
- Recall a single function parameter.

All except the single function store and recall are available from Remote. The contents of non-volatile memory are preserved for at least 2 years with the 6080A/AN's power off.

Each memory location contains all of the commonly accessed parameters needed to program the 6080A/AN. However, the RF on/off state is unaffected by memory recall operations. Certain other parameters are also not storable or recallable. These parameters are described in the Table 4D-1.

**Table 4D-1. Non-Storable/Recallable Parameters**

IEEE	Address Talk-Only/Listen-Only/Addressed Mode Language Service Request Enable Event Status Enable Instrument Status Change Enable Device Trigger Buffer Protected User Data
Memory	Dividers Memory Lock State
Miscellany	RF ON/OFF state Alternate External Reference Frequency Output Correction

**FRONT PANEL OPERATION**  
**MEMORY**

The non-volatile memory locations are organized as shown in Table 4D-2.

**Table 4D-2. Non-volatile Memory Locations**

LOCATIONS	DESCRIPTIONS
00	<p>A scratch pad location that is a copy of the last valid instrument state before a memory, store, or recall operation. On power-on, it contains the instrument state when the power was turned off.</p> <p>If the last memory operation was store, location 00 contains the instrument state in the memory location that was written by the store operation. If the last memory operation was a recall or sequence, location 00 contains the instrument state before the recall operation. The entry <input type="text" value="RCL"/> <input type="text" value="0"/> <input type="text" value="0"/> can be thought of as an "undo" command for memory operations.</p>
01-50	Available for storage and recall of preset states of the 6080A/AN.
51-95	Not used.
96	Holds the single parameter store and recall values. See the heading "Single Parameter Store and Recall" in this Section.
97	<p>The 6080A/AN Default Memory Location.</p> <p>All memory locations can be initialized to this setting with a Special Function command. See Section 4F, "Special Functions" for more information. The Instrument Preset State is presented in Appendix A.</p>
98	Reserved for future use.
99	The current instrument state.

## STORE AND RECALL ENTRY

## 4D-2.

Storage and recall of 6080A/AN instrument states in non-volatile memory locations is accomplished with the **STO** and **RCL** keys. Note that memory store and recall operations perform no action while digital sweep is active.

### SYNTAX:

#### Storing a 6080A/AN Instrument State

1. The current instrument state is stored by pressing the **STO** key.

The last memory location stored or recalled is displayed in the FREQUENCY display field.

2. The DATA keys are used to enter the two-digit memory location code. The entered code must contain both digits (e.g., 01, 02, ...50).

The location code appears in the FREQUENCY display field as it is entered. When the second digit key of the location code is released, the store operation is performed. From Remote, the \*SAV command is used to store an instrument state.

#### Recalling a 6080A/AN Instrument State

1. An instrument state is recalled by pressing the **RCL** key. The last memory location stored or recalled is displayed in the FREQUENCY display field.

2. Use the DATA keys to enter the memory location code of the desired instrument state. Again, the entered code must contain both digits of the two-digit memory location code. When the second digit key of the location code is released, the recall operation is performed. From Remote, the \*RCL command is used to recall an instrument state.

EXAMPLE: Recall the default memory location (98), program the RF Frequency to 6 MHz, and store it in memory location 06.

FRONT PANEL: **RCL** **9** **8** **FREQ** **6** **MHz V** **STO** **0** **6**

REMOTE: \*RCL 98; FREQ 6 MHZ; \*SAV 6

## MEMORY SEQUENCE ENTRY

4D-3.

The following information describes the method for sequencing through memory locations containing the 6080A/AN instrument states. Note that memory sequence operations perform no action while any digital sweep is active.

1. The  key allows the stored instrument states to be sequentially recalled. The sequence operation recalls the next higher memory location, starting from the most recent memory location stored or recalled. When the highest location is reached, the sequence starts over again at location 01. From Remote, the SEQ UP command accomplishes the same result.
2. While  is pressed, the next memory location number is displayed and the memory location is recalled. While this key is pressed, the function continues to sequence up through through memory locations.
3. The previous memory location may be recalled by entering  . This is equivalent to a sequence down function. While the  key is pressed, the function continues to sequence down through memory. The sequence down function “wraps” just as the sequence up function does. Entering   when the last location was location 01 recalls the highest available memory location. From Remote, the SEQ DOWN command accomplishes the same result.

## MEMORY SEQUENCE DIVIDERS

4D-4.

Memory sequence dividers can be defined that partition the 50 memory locations into multiple subsets for sequence operations. Once defined, a memory divider sets an upper bound for sequence up operations and a lower bound for sequence down operations. From the front panel, the dividers are defined with a Special Function command; from Remote, they are defined with the MEM\_DIVIDER command.

If no dividers have been defined, the sequence up operation sequences through every location and wraps around at location 50 back to location 01. The sequence down operation sequences down through every location and wraps around at location 01.

If, for example, a divider is defined at location 10, the memory locations are partitioned into two subsets (1-9 and 10-50). Note that the memory location corresponding to the divider location is included in the upper subset and is excluded from the lower subset.

Up to four memory dividers can be defined at once. Locations 01 and 50 are always used as the absolute boundaries regardless of the divider settings. Therefore, four dividers can provide up to five memory location subsets.

Entering     displays the current memory divider settings. The settings of all four of the dividers are displayed at once. Inactive dividers are displayed as location 00. If a numeric key is pressed while the divider settings are displayed, it is interpreted as a new divider entry, and the 6080A/AN enters the memory divider entry mode.

Once in the memory divider entry mode, the 6080A/AN expects settings for all four dividers to be entered before any are updated. Only numeric keys and the  key are allowed. All other keys immediately exit the entry mode and all partial entries are discarded. The  key skips to the next divider entry (if no partial entry has been made) to simplify the entry process if some of the dividers are to be changed but others are to be left unchanged. A divider is deleted when its location is specified as 00.

After all four divider settings have been updated, the entries are sorted and redisplayed for five seconds. The following example illustrates the memory divider setting display and the memory divider entry mode.

EXAMPLE: Current divider settings are 00,00,07,22. Change the divider settings to 00,07,14,31.

FRONT PANEL:

Enter    . The display shows:

00 00 07 22

To change divider #1 from 00 to 14 (entries will be sorted automatically), enter . The display shows:

d1 1\_ ?

Enter  to complete the entry. The display then shows divider #2:

d2 00 ?

Only three dividers are in use, so enter . The display then shows divider #3:

d3 07 ?

Leave this divider set to 07 by entering  again. The display then shows divider #4.

d4 22 ?

Enter . The display shows:

d4 3\_ ?

Enter . The display shows:

d4 31 ?

When the  key is released, the new divider settings are sorted and the display shows for five seconds:

00 07 14 31

Note that location 07 has moved from divider #3 to divider #2. Since the dividers are kept sorted, the actual divider number is not particularly important. However, the divider numbers do provide a way to uniquely identify each divider.

REMOTE: MEM\_DIVIDER 00,07,14,31

From the front panel, divider entries that are out of range are immediately rejected. To enter a valid divider following an erroneous entry, the entry process must be started over from the beginning. Duplicate divider entries are not checked as they are entered, but are eliminated during the sorting process.

**MEMORY LOCATION LOCK**

**4D-5.**

Memory locations 01 through 50 and 96 can be write-protected with a Special Function command from the front panel, or with the MEM\_LOCK command from Remote. When enabled, all memory recall and sequence operations operate as usual, but memory store operations are rejected.

SYNTAX:

	FRONT PANEL	REMOTE
Disable Memory Lock	<input type="button" value="SPCL"/> <input type="button" value="8"/> <input type="button" value="1"/> <input type="button" value="0"/>	MEM_LOCK OFF
Enable Memory Lock	<input type="button" value="SPCL"/> <input type="button" value="8"/> <input type="button" value="1"/> <input type="button" value="1"/>	MEM_LOCK ON

**RESET MEMORY TO DEFAULT MEMORY LOCATION**

**4D-6.**

The contents of the 50 non-volatile memory locations and memory locations 96 and 99 can be reset to the default memory location (97) with a Special Function command from the front panel as described below. (Memory location 97 is described in Appendix A, "Instrument Preset State".)

1. Entering     from the front panel, or sending the Remote command MEM\_RESET ON causes the message "Sto ?" to appear in the FREQUENCY display field.
2. If the  key is pressed within 10 seconds, the memory contents are reset to the memory location default (97).
3. If the  key is not pressed within 10 seconds, or if any other key is pressed, memory locations will not be changed.

**SINGLE PARAMETER STORE AND RECALL**

**4D-7.**

A single function parameter may be stored or recalled individually without affecting the entire instrument state. This allows individual storage and recall of commonly used RF frequency, RF amplitude, AM depth, FM/ $\phi$ M deviation, modulation frequency and modulation level parameter values. The stored parameters are saved in memory location 96. This location is initialized to the instrument default state if no parameters have been stored.

Pressing the  key followed by a FUNCTION key stores the current value of the function parameter for later use. Pressing the  key followed by a FUNCTION key recalls only the specified parameter leaving all other 6080A/AN parameters unchanged. For example, entering   saves the current RF frequency. Entering   recalls the parameter value without affecting any other programmed functions.

The RF frequency store and recall operations preserve the state of Relative Frequency Mode along with the offset and the reference value. Likewise, the RF amplitude store and recall operations preserve the state of Relative Amplitude Mode along with the offset and the reference value.



## Section 4E

# Sweep

### GENERAL DESCRIPTION

#### 4E-1.

The 6080A/AN provides digital sweep capability for both RF frequency and RF amplitude. Each has three modes of operation: auto sweep, manual sweep, and single sweep.

Auto digital sweep mode cycles continuously through the sweep range, with a selected dwell time at each discrete frequency or amplitude. The display reflects the center frequency or amplitude; the bright digit remains on. All numeric function entries are allowed while auto sweep is active.

Manual digital sweep mode is used to increment and decrement within the sweep range with the edit knob, in units of the sweep increment. The display reflects the output (relative mode off) or offset (relative mode on) frequency or amplitude. The display bright digit is turned off, and any key entry that relies on the position of the bright digit is disallowed. This includes function selection, numeric entry, and units entry. All other front panel keys are allowed.

Single digital sweep mode runs through the sweep range once, with a selected dwell time at each discrete frequency or amplitude. The display is continuously updated to reflect the output (relative mode off) or offset (relative mode on) frequency or amplitude, with the bright digit off. Only the RF OUTPUT  ON/OFF ,  STATUS ,  AUTO and  MANUAL keys are active.

When any mode of digital sweep is active, a 0 to 10V stepped output ramp is available at the rear panel connector labeled "AUX". This signal is an analog of the progress of the sweep. A TTL-level pulse is available on this connector for X-Y recorder penlift control or for oscilloscope Z-axis blanking. When an auto or single sweep reaches the end of its range, the signal is driven high for a 100 millisecond (minimum) pulse.

In all sweep modes, memory store and recall operations (the  STO ,  RCL , and  SEQ keys) are disallowed. If the 6080A/AN is powered off while any sweep is active, the active sweep is terminated, and the power-down memory location (location 00) is programmed to the center frequency or amplitude.

**SELECTING THE DIGITAL SWEEP FIELD**

**4E-2.**

Selection of frequency sweep or amplitude sweep from the front panel is performed by pressing the desired function key, followed by either sweep parameter. No numeric entry or unit entry is necessary to change the sweep field. The SWEEP\_FIELD command is used to select the desired function from Remote. The selected function has the SWP annunciator lit in its display field. This operation ties the selected function (frequency or amplitude) to the sweep mode controls, but does not activate any of the sweep modes (auto, manual, or single). The sweep field may not be changed while a sweep is active.

SYNTAX:

	FRONT PANEL	REMOTE
Select Frequency Sweep	[ FREQ ] [ SWEEP WIDTH ] OR [ FREQ ] [ SWEEP INCR ]	SWEEP_FIELD FREQ
Select Amplitude Sweep	[ AMPL ] [ SWEEP WIDTH ] OR [ AMPL ] [ SWEEP INCR ]	SWEEP_FIELD AMPL

**DIGITAL SWEEP MODES**

**4E-3.**

From the front panel, Auto and Manual Sweep Mode are enabled and disabled by pressing keys located in the SWEEP ON/OFF section, while Single Sweep is enabled with a Special Function command. From Remote, the SWEEP command is used to select a Sweep Mode.

The sweep on/off keys operate as toggle functions; the key used to enable a sweep mode is pressed again to disable the mode. For example, pressing the [ AUTO ] key once enables the auto sweep mode and pressing the [ AUTO ] key again turns off the auto sweep. The same holds true for the [ MANUAL ] key. Since the single sweep mode is enabled by Special Function and terminates automatically, no direct toggle capability is provided. However, pressing either the [ AUTO ] OR [ MANUAL ] key twice terminates a single sweep. From Remote, the SWEEP OFF command turns off any active sweep.

If [ MANUAL ] is pressed while a single or auto sweep is active, the manual sweep mode is entered precisely at the point in the sweep range where the 6080A/AN was at the time the key was pressed. This allows the neighborhood of a particular frequency or amplitude in the sweep range to be examined in greater detail. If [ AUTO ] is pressed again, the sweep resumes from the last point where it was left in the manual sweep.

SYNTAX:

	FRONT PANEL	REMOTE
Initiate Auto Sweep	[ AUTO ]	SWEEP AUTO
Initiate Manual Sweep	[ MANUAL ]	SWEEP MANUAL
Initiate Single Sweep	[ SPCL ] [ 8 ] [ 8 ] [ 2 ]	SWEEP SINGLE
Terminate Sweep	[ AUTO ] if AUTO on [ MANUAL ] if MANUAL on	SWEEP OFF

**DIGITAL SWEEP SYMMETRY****4E-4.**

Both symmetric (sweep range is evenly centered about displayed frequency or amplitude) and asymmetric sweep (displayed frequency or amplitude is an endpoint of the sweep range) are selectable with a Special Function command from the front panel. From Remote, the SWEEP\_SYM command is used. When asymmetric sweep is selected the ASYM annunciator is lit. If a selection is made that would cause an invalid sweep range while a sweep is active, the entry is rejected.

## SYNTAX:

	FRONT PANEL	REMOTE
Select Symmetric Sweep	SPCL 8 8 0	SWEEP_SYM SYMM
Select Asymmetric Sweep	SPCL 8 8 1	SWEEP_SYM ASYM

**DIGITAL SWEEP DWELL TIME****4E-5.**

The time that an active auto or single sweep dwells at each discrete frequency or amplitude in the sweep range can be adjusted. This dwell time is in addition to the nominal switching time for frequency and amplitude. One of six different minimum dwell times can be selected with a Special Function command from the front panel, or with the SWEEP\_DWELL command from Remote. The selected dwell time remains in effect for all subsequent sweep modes.

## SYNTAX:

	FRONT PANEL	REMOTE
Select 0 ms Dwell	SPCL 8 9 0	SWEEP_DWELL 0 MS
Select 20 ms Dwell	SPCL 8 9 1	SWEEP_DWELL 20 MS
Select 50 ms Dwell	SPCL 8 9 2	SWEEP_DWELL 50 MS
Select 100 ms Dwell	SPCL 8 9 3	SWEEP_DWELL 100 MS
Select 200 ms Dwell	SPCL 8 9 4	SWEEP_DWELL 200 MS
Select 500 ms Dwell	SPCL 8 9 5	SWEEP_DWELL 500 MS

## DIGITAL FREQUENCY SWEEP

4E-6.

The 6080A/AN allows digital frequency sweep between any two valid frequencies with a resolution of 1 Hz per increment.

Four parameters define the sweep:

- The RF frequency in effect before the sweep is enabled becomes the center frequency if symmetric sweep is selected, or the start frequency if asymmetric sweep is selected. It is generically called the center frequency ( $F_c$ ).
- The frequency sweep width ( $F_w$ ) is the total width of the sweep and may be either a positive or a negative quantity.
- The frequency sweep increment ( $F_i$ ) is the increment size and must be a positive quantity. The sweep increment may be larger than the absolute value of the sweep width.
- Sweep symmetry is selected by Special Function, as described in the under the heading "Digital Sweep Symmetry".

The following equations show the relationship of these parameters.

### NOTE

*The progression of the sweep is always from F1 to F2. (Fw can be negative.)*

Symmetric sweep: ASYM annunciator is off.

$$F1 = \text{start frequency} = F_c - F_w/2$$

$$F2 = \text{end frequency} = F_c + F_w/2$$

Asymmetric sweep: ASYM annunciator is lit.

$$F1 = \text{start frequency} = F_c$$

$$F2 = \text{end frequency} = F_c + F_w$$

Some sweep parameters may be changed while sweep is active. Any parameter change that would result in an invalid sweep condition is rejected, and the sweep continues with the existing sweep parameters. If an attempt is made to start a sweep with such a combination of parameters, the sweep mode selection is rejected.

During auto sweep, both sweep width and sweep increment can be inspected and modified, and the center frequency can be modified, edited, or stepped. If the entry is valid, the new sweep range or increment takes effect immediately for the sweep. These parameters cannot be displayed or changed during manual or single sweep, although the center frequency may be stepped during manual sweep. Sweep symmetry may be changed at any time (so long as the resulting sweep range is valid) for auto or manual sweep. Sweep symmetry may not be changed while a single sweep is active.

A sweep in relative mode is possible by enabling relative frequency mode before entering a sweep. However, relative mode may not be enabled or disabled while a sweep is active.

**Frequency Sweep Width Entry****4E-7.**

The frequency sweep width can be selected for entry by first pressing the **FREQ** key to select the FREQUENCY display field, then pressing the **SWEEP WIDTH** key. Upon programming a new sweep width, the value is held momentarily in the FREQUENCY display field. A negative sweep width can be entered; this causes the 6080A/AN to sweep in the reverse direction, that is, starting at the high frequency and proceeding towards the low frequency.

FREQUENCY SWEEP WIDTH	
RANGE	RESOLUTION
±1 to ±1056 MHz	1 Hz

SYNTAX:

**FREQ** **SWEEP WIDTH** -- numeric data -- **MHz|V**  
**kHz|mV**  
**Hz|µV**

EXAMPLE: Set Frequency Sweep Width to 230 MHz

FRONT PANEL: **FREQ** **SWEEP WIDTH** **2** **3** **0** **MHz|V**REMOTE: **FREQ\_SWIDTH 230 MHz****Frequency Sweep Increment Entry****4E-8.**

The frequency sweep increment can be selected for entry by first pressing the **FREQ** key, to select the FREQUENCY display field, then pressing the **SWEEP INCR** key. Upon programming a new sweep increment, the new value is held momentarily in the FREQUENCY display field.

FREQUENCY SWEEP INCREMENT	
RANGE	RESOLUTION
1 to 1056 MHz	1 Hz

SYNTAX:

**FREQ** **SWEEP INCR** -- numeric data -- **MHz|V**  
**kHz|mV**  
**Hz|µV**

EXAMPLE: Set Frequency Sweep Increment to 230 MHz

FRONT PANEL: **FREQ** **SWEEP INCR** **2** **3** **0** **MHz|V**REMOTE: **FREQ\_SINCR 230 MHz**

## Digital Frequency Sweep Example

4E-9.

EXAMPLE: Configure a digital frequency sweep From 500 MHz to 540 MHz, with a sweep increment of 100 kHz and a dwell of 0 ms at each point. Enable Single sweep for this configuration.

1. Select 520 MHz RF frequency

FRONT PANEL:

REMOTE: FREQ 520 MHZ

2. Select 40 MHz frequency sweep width and select frequency as the active sweep field

FRONT PANEL:

REMOTE: FREQ\_SWIDTH 40 MHZ ; SWEEP\_FIELD FREQ

3. Select 100 kHz frequency sweep increment

FRONT PANEL:

REMOTE: FREQ\_SINCR 0.1 MHZ

4. Select symmetric sweep

FRONT PANEL:

REMOTE: SWEEP\_SYM SYMM

5. Select 0 ms sweep dwell time

FRONT PANEL:

REMOTE: SWEEP\_DWELL 0 MS

6. Enable single sweep

FRONT PANEL:

REMOTE: SWEEP SINGLE

## DIGITAL AMPLITUDE SWEEP

4E-10.

The 6080A/AN allows both digital linear and digital logarithmic amplitude sweep. If all amplitude sweep parameters are specified in linear (voltage) quantities, the sweep will be digital linear. If all amplitude sweep parameters are specified in logarithmic (dBm, dBmV, dB $\mu$ V or dBf) quantities, the sweep will be digital logarithmic.

Four parameters define the sweep:

- The RF amplitude in effect before the sweep is enabled becomes the Center Amplitude if symmetric sweep is selected, or the start amplitude if asymmetric sweep is selected. It is generically called the Center Amplitude (Ac).
- The amplitude sweep width (Aw) is the total width of the sweep and may be either a positive or a negative quantity.

- The amplitude sweep increment ( $A_i$ ) is the increment size and must be a positive quantity. The sweep increment may be larger than the absolute value of the sweep width.
- Sweep symmetry is selected by Special Function.

The following equations show the relationship of these parameters.

*NOTE*

*The progression of the sweep is always from  $A_1$  to  $A_2$ . " $A_w$ " can be negative.*

Symmetric sweep: ASYM annunciator is off.

$$A_1 = \text{start amplitude} = A_c - A_w/2$$

$$A_2 = \text{end amplitude} = A_c + A_w/2$$

Asymmetric sweep: ASYM annunciator is lit.

$$A_1 = \text{start amplitude} = A_c$$

$$A_2 = \text{end amplitude} = A_c + A_w$$

Certain sweep parameters may be changed while sweep is active. Any parameter change that would result in an invalid sweep condition is rejected and the sweep continues with the existing sweep parameters. If an attempt is made to start a sweep with such a combination of parameters, the sweep mode selection is rejected.

During auto sweep, sweep width and sweep increment can be inspected and modified, the center amplitude can be edited or stepped, and sweep symmetry may be changed. If the entry is valid, the new sweep range or increment takes effect immediately. With the exception of stepping the center amplitude during manual sweep, these parameters cannot be displayed or changed during manual or single sweep.

The center amplitude, sweep width, and sweep increment must all have consistent units (dB or volts). If these parameters have inconsistent units, the amplitude sweep will be rejected when a sweep mode (auto, manual, or single) is enabled. Likewise, the units of the sweep parameters may not be converted while amplitude sweep is active.

A sweep in relative mode is possible by enabling relative amplitude mode before entering a sweep. However, relative mode may not be enabled or disabled while a sweep is active.

The maximum sweep width in either logarithmic or linear mode is restricted to 20 dB (approximately a 10:1 ratio). Furthermore, when in linear mode, the ratio of the maximum output voltage in the amplitude sweep to the sweep increment cannot exceed 999.

### Amplitude Sweep Width

4E-11.

The amplitude sweep width can be selected for entry by first pressing the **AMPL** key to select the AMPLITUDE display field, then pressing the **SWEEP WIDTH** key. When a new sweep width is programmed, the value is held momentarily in the AMPLITUDE display field. A negative sweep width can be entered; this causes the 6080A/AN to sweep in the reverse direction, that is, starting at the larger amplitude and proceeding towards the smaller amplitude.

AMPLITUDE SWEEP WIDTH	
RANGE	RESOLUTION
± 0.1 dB to ±20 dB	0.1 dB
±10 nV to ±2.24 V	3 digits

SYNTAX:

**AMPL** **SWEEP WIDTH** -- numeric data -- **dB(m)**  
**MHz|V**  
**kHz|mV**  
**Hz|µV**

EXAMPLE: Set Amplitude Sweep Width to 12 dB

FRONT PANEL: **AMPL** **SWEEP WIDTH** **1** **2** **dB(m)**

REMOTE: AMPL\_SWIDTH 12 DB

### Amplitude Sweep Increment Entry

4E-12.

THE amplitude sweep increment can be selected for entry by first pressing the **AMPL** key to select the AMPLITUDE display field, then pressing the **SWEEP INCR** key. Upon programming a new sweep increment, the new value is held momentarily in the AMPLITUDE display field.

AMPLITUDE SWEEP INCREMENT	
RANGE	RESOLUTION
0.1 to +20 dB	0.1 dB
10 nV to 2.24 V	3 digits

SYNTAX:

**AMPL** **SWEEP INCR** -- numeric data -- **dB(m)**  
**MHz|V**  
**kHz|mV**  
**Hz|µV**

EXAMPLE: Set amplitude sweep increment to 0.5 dB

FRONT PANEL: **AMPL** **SWEEP INCR** **0** **.** **5** **dB(m)**

REMOTE: AMPL\_SINCR 0.5 DB



## Example Digital Amplitude Sweep

4E-13.

EXAMPLE: Configure a digital amplitude sweep from -20.0 dBm to -15.0 dBm, with a sweep increment of 0.1 dB and a dwell of 100 ms at each point. Enable Auto sweep for this configuration.

1. Select -20.0 dbm RF amplitude

FRONT PANEL:

REMOTE: AMPL -20 DBM

2. Select 5 dB amplitude sweep width and select amplitude as the active sweep field

FRONT PANEL:

REMOTE: AMPL\_SWIDTH 5 DB ; SWEEP\_FIELD AMPL

3. Select 0.1 dB amplitude sweep increment

FRONT PANEL:

REMOTE: AMPL\_SINCR 0.1 DB

4. Select asymmetric sweep

FRONT PANEL:

REMOTE: SWEEP\_SYM ASYM

5. Select 100 ms sweep dwell time

FRONT PANEL:

REMOTE: SWEEP\_DWELL 100 MS

6. Enable auto sweep

FRONT PANEL:

REMOTE: SWEEP AUTO

## CALIBRATION OF RECORDER/OSCILLOSCOPE

4E-14.

To calibrate an X-Y plotter/recorder or oscilloscope to the 6080A/AN X-axis (sweep DAC) output and the Blanking/Penlift signals, use the following procedure:

1. Set the X-axis output to 0 volts:

Enable manual sweep and turn the edit knob to the start frequency (F1) or the start amplitude (A1).

2. Set the X-axis output to +10 volts:

Enable manual sweep and turn the edit knob to the end frequency (F2) or the end amplitude (A2).

The Blanking/Penlift signal is maintained “low” for the above conditions; it is maintained “high” if no sweep is active.

## ANALOG FREQUENCY SWEEP

4E-15.

It is possible to configure the 6080A/AN FM circuitry to perform a fast frequency sweep that is symmetric about the RF frequency. This mode is entirely controlled by the programmed modulation parameters and is not related to the synthesized digital sweep.

Three parameters must be configured to perform a fast frequency sweep:

- The sweep rate, determined by the modulation frequency.

At lower modulation frequencies, it may be necessary to enable Low Rate FM or External DC FM. See Section 4C, “Modulation” for more information.

- The programmed FM deviation (one-half of the sweep width).

The maximum FM deviation allowed depends on the RF frequency. See Section 4C, “Modulation” for more information.

The following equations determine the start and end frequencies:

$$F1 = \text{start frequency} = \text{RF Frequency} - \text{FM deviation}$$

$$F2 = \text{end frequency} = \text{RF Frequency} + \text{FM deviation.}$$

- The triangle internal modulation waveform must be selected.

See Section 4C, “Modulation” for more information.

Once internal FM is enabled, the RF frequency sweeps from F1 to F2, then back down to F1 each period (period = 1/Modulation Frequency).

EXAMPLE: Configure an analog frequency sweep From 79.5 MHz to 80.5 MHz, with a sweep rate of 10 Hz.

1. Select 80-MHz RF frequency

FRONT PANEL:

REMOTE: FREQ 80 MHZ

2. Select 10-Hz modulation frequency

FRONT PANEL:

REMOTE: MODF 10 HZ

3. Select 500-kHz FM deviation

FRONT PANEL:

REMOTE: FM 500 KHZ

4. Select triangle internal modulation waveform

FRONT PANEL:

REMOTE: MOD\_WAVE TRIANGLE

5. Enable internal FM modulation

FRONT PANEL:

REMOTE: INT\_FM ON



## Section 4F Special Functions

### GENERAL DESCRIPTION

4F-1.

Special Functions are divided into three functional groups:

- Stored-mode
- Immediate action
- Hidden parameter display/entry.

All are activated by pressing the  key followed by either a two- or three-digit numeric code.

Stored-mode special functions change a specific operating mode of the 6080A/AN. Examples are RF Frequency Relative mode, Low-rate FM mode, and High-rate  $\phi$ M mode. All of the active stored-mode special function numeric codes can be viewed by pressing the  key.

Each of the stored-mode special functional groups is allocated a decade of special function numeric codes. For example, Relative RF Frequency OFF/ON is 20/21, low-rate FM OFF/ON is 710/711, and High-rate  $\phi$ M OFF/ON is 720/721. The unit digit of the code determines whether functions of this type are off or on (0 = OFF, 1 = ON). The 6080A/AN's default, preset state forces these functions to the OFF state.

All enabled stored-mode functions are cleared with Special Function 00.

Some of the stored-mode functions have more than two choices. For example, there are six selections (890 through 895) for sweep dwell time, and three selections (750 through 752) for the internal modulation waveform. Again, the unit digit of the code determines the selection within the decade, with the zero-state the default state.

Immediate action special functions typically perform an immediate action without affecting the stored state of the 6080A/AN. Examples of these type of functions include display of the software revision level and execution of self-tests. Since immediate action functions do not change the stored state of the 6080A/AN, their special function numbers are not allocated in decades.

Hidden parameter special functions are for display and modification of 6080A/AN parameters that are not normally displayed on the front panel. Hidden parameter special functions are used primarily when the related parameter may take on a wide range of values and it is impractical to use a sequence of special function numbers. Since the special function number is not used as an indication of the function state, they are not allocated in decades. An example of this type of function is special function 10, which displays and is used to set the IEEE-488 address.

Table 4F-1 lists the Special Functions by action. Appendix B contains a list of the special function codes.

**FRONT PANEL OPERATION**  
**SPECIAL FUNCTIONS**

**Table 4F-1. Special Function Codes**

<b>SPECIAL FUNCTION DESCRIPTION</b>	<b>FRONT PANEL</b>	<b>REMOTE COMMAND</b>	<b>LIGHTS SPCL ANNUNCIATOR WHEN ENABLED</b>
<b>FREQUENCY</b> Relative frequency mode External reference input frequency	20,21 760,761	FREQ_REL EXTREF_FREQ	
<b>AMPLITUDE</b> Relative amplitude mode Fixed-range amplitude Amplitude display units EMF-Volts amplitude display mode	30,31 50,51 840-843 850,851	AMPL_REL AMPL_RANGE AMPL AMPL_EMFOUT	*
<b>MODULATION</b> Modulation oscillator output Enter modulation frequency to 0.1 Hz Low-rate FM High-rate ØM Low-distortion/fixed-range FM Internal pulse modulation Modulation oscillator waveform Enter pulse width	40, 41 62 710,711 720,721 730-732 740,741 750-758 759	MODOUT MODF LORATEFM HIRATEPM FM_RANGE INT_PULSE MOD_WAVE PULSE_WIDTH	*  * * * *
<b>SWEEP</b> Sweep dwell time Sweep symmetry Initiate single sweep	890-895 880,881 882	SWEEP_DWELL SWEEP_SYM SWEEP_SINGLE	
<b>MEMORY</b> Reset memory locations Display/Set memory sequence dividers Lock memory store operations	801 802 820,821	MEM_RESET MEM_DIVIDER MEM_LOCK	
<b>REMOTE</b> Display/Set IEEE-488 address Display/Set IEEE-488 address mode Display/Set IEEE-488 language Display/Enter service request mask Set user request SRQ Clear SRQ	10 11 12 13 14 15	n/a n/a GAL *SRE n/a n/a	
<b>MISCELLANEOUS</b> Clear special functions Restore Instrument Preset State Initiate power-on self tests Display self test results Display option loading status Display software revision level Disable display Step key repeat rate Knob and step key operation	00 01 02 03 08 09 770,771 860-862 870-873	SPCL 00 SPCL 01 *TST? STATUS *IDN? *IDN? DISPLAY KEY_RATE KNOB_STEP	*

**Table 4F-1. Special Function Codes (cont)**

SPECIAL FUNCTION DESCRIPTION	FRONT PANEL	REMOTE COMMAND	LIGHTS SPCL ANNUNCIATOR WHEN ENABLED
<b>SERVICE</b> Amplitude compensation Output compensation data See Service Manual for Others	920-922 930,931	AMPL_COMP AMPL_CMPDAT	*

**SPECIAL FUNCTION ENTRY**

**4F-2.**

The Special Function code is a two- or three-digit number. Special Functions 00 through 19 cause an immediate action to be performed. Special functions 20 through 59 and 600 through 999 cause a change to the instrument state. The first digit indicates the classification of the special function, and the last digit specifies the particular special function. A special function is executed when the last digit of the special function code is entered.

SYNTAX:

<n> = 0..9:

Special Functions 00 through 59      <n> <n>

Special Functions 600 through 999      <n> <n> <n>

**VIEWING ENABLED SPECIAL FUNCTIONS**

**4F-3.**

A list of the active stored-mode special functions is displayed while the  key is pressed. A special function is defined as active, and its code is displayed, only when it is programmed to a state other than its default state. If all special functions are in their default or OFF state, the code 00 is displayed.

Up to four Special Function codes are displayed at a time. If more than four special functions are active, repeatedly pressing the  key scrolls through the list. For more information on the operation of the Special Function status display, see Section 4G, "Error and Status Reporting".

**THE SPCL ANNUNCIATOR**

**4F-4.**

Several special functions enable operating modes that cause a distinct change to the state of the 6080A/AN, but do not have a dedicated annunciator in the display. The SPCL annunciator in the FREQUENCY display field is lit when any of these special operating modes are enabled.

In addition, the SPCL annunciator is lit for special functions for which there is a dedicated annunciator, but are context dependent. For example, enabling the low-rate FM special function lights the SPCL annunciator immediately, but the LO RATE annunciator is lit only if Internal or External FM is also enabled.

**MISCELLANEOUS SPECIAL FUNCTIONS**

**4F-5.**

**Clear Special Functions**

**4F-6.**

Enabled stored-mode Special Functions can be cleared with Special Function 00.

**Restore Instrument Preset State** **4F-7.**

Enabled stored-mode can also be cleared with Special Function 01. This function recalls memory location 97 clears all sweep modes and cal/comp procedures. The scope of Special Function 01 is detailed in Appendix A.

**Execute Self-Test and Display Self-Test Results** **4F-8.**

The 6080A/AN performs self-tests of its digital and analog hardware at power-on or by special function. Self-tests can be run at any time with Special Function 02.

The test sequence can be terminated immediately by pressing any front panel key. At the end of the test sequence, the 6080A/AN assumes the power-on-state. Numeric error codes are displayed if one or more of the self tests failed. If the tests were aborted with a key entry, error code 301 is displayed to indicate that the tests were not run to completion.

The results of the self-tests can be displayed with Special Function 03. See Appendix E for the status codes and their explanations.



**Display Loaded Options** **4F-9.**

Special Function 08 causes the loaded instrument options to be displayed for approximately 5 seconds or until another key is pressed.



**Display Instrument ID and Software Revision Level** **4F-10.**

Special Function 09 causes the instrument ID and software revision level to be displayed in the display fields for approximately 5 seconds or until another key is pressed.

**Blank Front Panel Display** **4F-11.**

The front panel display can be blanked with Special Function 771. This special function blanks the display and also disables the edit knob and the front panel keys, except for the  key. As a result, the remote command processing time is reduced by approximately 15%. Pressing the  key restores the display, as well as the knob and key functions.

**Select Repeat Rate for Step Keys** **4F-12.**

The repeat rate for the front panel step  and  keys is selected with Special Functions 860 through 862. The default repeat rate for the step keys is medium, corresponding to Special Function 860. Special Function 861 selects a fast repeat rate, while Special Function 862 selects a slow repeat rate.

**Configure Edit Knob and Step Keys** **4F-13.**

The front panel edit knob can be disabled and the functional role of the step increment/decrement keys and the edit knob can be modified with Special Functions 871 through 873 (see Table 4F-2). With Special Function 872, the bright digit remains displayed even though edit operations are disabled.



Table 4F-2. Functions of Edit Knob and Step Keys

SPECIAL FUNCTION	EDIT KNOB	STEP INCREMENT/ DECREMENT KEYS
870 871 872 873	enabled enabled disabled disabled	enabled as step enabled as edit enabled as step enabled as edit



## Section 4G

# Error and Status Reporting

### GENERAL DESCRIPTION

**4G-1.**

There are five types of status information that the 6080A/AN generates:

- Rejected Entry Errors
- Instrument Overrange/Uncal Status
- Self-Test Status
- Calibration/Compensation Data Checksum Status
- Calibration/Compensation Data Origin Status

The rejected entry annunciator REJ ENTRY is flashed whenever a front panel or Remote entry is rejected. Numeric data in one of the display fields may also flash to indicate the rejected value. Any function key may be pressed to clear the flashing entry and the REJ ENTRY annunciator.

The STATUS annunciator is lit but not flashed to indicate when the 6080A/AN is operating outside its specified performance range. If abnormal operation or aberrated output occurs, the STATUS annunciator is flashed to emphasize the severity of the problem.

Since there is never more than one rejected entry error at a time, rejected entry errors are always given precedence over the status codes. To avoid ambiguity, the STATUS annunciator is always turned off when the rejected entry annunciator is flashing.

The Self-Test Status and Calibration/Compensation Data Status are not presented in the normal operation of the 6080A/AN. A Special Function command is used to display the active status codes for these conditions.

### THE STATUS KEY

**4G-2.**

When the REJ ENTRY annunciator is flashing, pressing the STATUS key displays the Rejected Entry Error Code; when the STATUS annunciator is flashing or lit, pressing the STATUS key displays the Overrange or Uncal Status Codes. These codes provide detailed information on the nature of the rejected entry or status condition.

To avoid ambiguity, every Rejected Entry, Overrange/Uncal, Self-Test and Calibration Compensation memory condition has a unique status code. These codes are organized numerically to facilitate their interpretation, as shown in Table 4G-1.

A numeric list and explanation of all of the error and status codes is presented in Appendixes C, D, and E.

**Table 4G-1. Status Code Descriptions**

ERROR/STATUS CODE	INTERPRETATION
00	No Errors or Status
01 - 199	Rejected Entry Errors
201 - 299	Instrument Overrange or Uncal Status
301 - 399	Self-Test Status
401 - 499	Calibration/Compensation Data Checksum Status
501 - 599	Calibration/Compensation Data Origin Status

When the front panel REJ ENTRY annunciator is flashing, pressing the **STATUS** key displays a numeric code, in the MODULATION display field, indicating the specific reason why the entry was rejected. From Remote, the ERROR? command is used to query errors.

When the front panel STATUS annunciator is lit or flashing, pressing the **STATUS** key displays one or more numeric codes detailing the set of overrange or uncal conditions. From Remote, the STATUS? command is used to query status.

Up to four codes can be displayed at a time. If more than four status codes are active, repeatedly pressing the **STATUS** key will scroll through the active codes. Only three codes at a time are displayed when the active list is scrolled through. Three dots appear in the fourth (rightmost) field to indicate that there are additional codes.

**SELF-TEST AND CALIBRATION/COMPENSATION DATA STATUS 4G-3.**

Self-Test, Calibration/Compensation Data Checksum, and Origin status codes can also be displayed. Each set of status codes are displayed with a Special Function and scrolled using the **STATUS** key like the overrange/uncal status codes. From Remote, the STATUS command is used to load the status queue with the requested information, and the STATUS? command is used to query the status. The Calibration/Compensation Data Checksum and Origin Status codes are described in the 6080A/AN Service Manual.

**SYNTAX:**

	FRONT PANEL	REMOTE
Display/Load Overrange /Uncal Status	<b>STATUS</b>	STATUS UNCAL STATUS?
Display/Load Self Test Status	<b>SPCL</b> <b>0</b> <b>3</b> <b>STATUS</b>	STATUS SELFTEST STATUS?
Display/Load Cal/Comp Data Checksum Status	<b>SPCL</b> <b>0</b> <b>4</b> <b>STATUS</b>	STATUS CHECKSUM STATUS?
Display/Load Cal/Comp Data Origin Status	<b>SPCL</b> <b>0</b> <b>5</b> <b>STATUS</b>	STATUS ORIGIN STATUS?

# Section 5

## Remote Operation

### INTRODUCTION

5-1.

The 6080A/AN Signal Generator operates directly from the front panel controls or under remote control of an instrument controller or computer. The following sections describes how to connect, configure, and operate the 6080A/AN in the remote mode.

The 6080A/AN is fully programmable for use on the IEEE Standard 488.1 interface bus (IEEE-488 bus). The interface also complies with supplemental standard IEEE-488.2. Devices connected to the bus in a system are designated as talkers, listeners, talker/listeners, or controllers. Under the remote control of an instrument controller such as the Fluke 1722A, the 6080A/AN operates exclusively as a talker/listener on the IEEE-488 bus. This operation is described in Section 5A, "Remote Programming". The programming commands are listed in Section 5B, "Remote Command Tables".

The 6080A/AN can also be operated on the IEEE-488 bus without an instrument controller in a talk-only or listen-only mode. In this mode, two 6080A/ANs can be configured to track each other in operation. This mode is described in Section 5C, "Listen-Only/Talk-Only Operation".

Compatibility language capability is included to emulate Fluke Models 6060A, 6060B, 6061A, 6062A, 6070A, and 6071A. This capability allows the 6080A/AN to emulate these instruments in response to commands and allows substituting a 6080A/AN into a system with no or, in some cases, minor software modifications. This language is described in Section 5D "Compatibility Languages".

For an introduction to the basics of the IEEE-488 interface bus, request Fluke Application Bulletin AB-36, "IEEE Standard 488-1978 Digital Interface for Programmable Instrumentation."

### SETTING UP THE IEEE-488 INTERFACE

5-2.

The 6080A/AN is set at the Fluke factory to operate in the normal talker/listener mode. If the listen-only/talk-only modes or the compatibility languages are to be used, follow the setup procedures described in this section.

### Address Setup Procedure

5-3.

Setting up the 6080A/AN on the IEEE-488 bus requires only a choice of address and connection to a controller. The address is set at the Fluke factory to 2. To change the 6080A/AN address, proceed as follows:

Enter    to display the current IEEE-488 address. The address is shown in the FREQUENCY display field, and the talker/listener mode is shown in the AMPLITUDE display field. For example:

EXAMPLE	EXPLANATION
"Addr 01 ? "	Normal mode with address of 1
"Addr 12 ? to"	Talk-only mode, address is ignored
"Addr 23 ? Lo"	Listen-only mode, address is ignored

Enter two digits for the desired new address. Addresses are allowed in the range of 0 to 30. The new address is displayed for 2 seconds.

The address is stored in non-volatile memory and is retained when the power is turned off.

### Talker/Listener Mode Selection Procedure

5-4.

When using an IEEE-488 bus controller, the 6080A/AN should be set to operate in the addressed mode. A talk-only and listen-only mode are provided for use on the IEEE-488 bus without a controller. Two 6080A/ANs can be connected together to track each other with the talk-only and listen-only modes.

Enter    to display the current talker/listener mode in the FREQUENCY display field.

EXAMPLE	EXPLANATION
Addr ?	Normal (Addressed) mode
to ?	Talk-only mode
Lo ?	Listen-only mode

When the 6080A/AN is in talk-only or listen-only, it is always addressed to talk or listen, so the ADDR annunciator on the front panel is always lit.

Enter  to select the addressed mode,  to select the talk-only mode, and  to select the listen-only mode. The new talker/listener mode is displayed for 2 seconds.

The talker-only or listener-only mode is stored in non-volatile memory and retained when the power is turned off.

### Compatibility Language Selection Procedure

5-5.

The default language for the 6080A/AN is described in this section. Two compatibility languages are included; one for the Fluke 6060-family signal generators and one for the Fluke 6070-family signal generators.

Enter    to display the current IEEE-488 language in the FREQUENCY display field.

EXAMPLE	EXPLANATION
L6080 ?	6080 language
L6060 ?	6060 language
L6070 ?	6070 language

Enter  for the 6080 (6080A/AN),  for the 6060 (6060A, 6060B, 6061A, or 6062A), and  for the 6070 (6070A or 6071A) language. The new language will be displayed for 2 seconds.

If the 6060 or 6070 language has been selected, the 6080A/AN will not respond to the commands described in this section. See Section 5D, “Compatibility Languages” for more information.

The language is stored in non-volatile memory and is retained when the power is turned off.





# Section 5A

## Remote Programming

### INTRODUCTION

#### 5A-1.

Communication between the controller and the 6080A/AN consists of interface messages and commands. Interface messages are defined by the IEEE-488.1 standard and control the lowest level of bus communication. Interface messages are handled automatically by the controller. (The interface messages that the 6080A/AN accepts and sends are listed in Tables 5A-4 and 5A-5.) Commands are sent to the 6080A/AN literally, for example, with the Fluke 1722A BASIC PRINT statement. The commands are described in Tables 5B-1 and 5B-3. There are three types of commands:

1. Common commands

Commands that start with an asterisk which are defined by the IEEE-488.2 standard.

2. Device-dependent commands

Commands specific to the 6080A/AN.

3. Queries

Commands that cause the 6080A/AN to send a response to the controller. (These commands always end with a question mark (?).

A controller program first needs to initialize the interface and the 6080A/AN. The following sample program can be used.

```
10 INIT PORT 0 \ REMOTE @2           ! PUT THE 6080A/AN INTO REMOTE
20 CLEAR @2                          ! CLEAR IEEE-488 INTERFACE
25 PRINT @2, "GAL"                   ! SET TO 488.2 LANGUAGE
30 PRINT @2, "**CLS; *RST"            ! CLEAR ERRORS AND RESET 6080A/AN
40 PRINT @2, "**SRE 0"                ! DON'T GENERATE SRQs
```

If the programmer wishes to use SRQs, the \*SRE, \*ESE, and ISCE commands should be used to enable the desired event. Refer to "Checking the Instrument Status" later in Section 5A for more information.

Programming the 6080A/AN involves sending the desired commands to the 6080A/AN as shown in the following program.

```
100 PRINT @2, "FREQ 100 MHZ; AMPL -15 DBM" ! PROGRAM FREQUENCY AND AMPLITUDE
110 PRINT @2, "RFOUT ON"                   ! TURN RF OUTPUT ON
120 PRINT @2, "FM 1.2 KHZ; EXTAC_FM ON"    ! PROGRAM DEVIATION & ENABLE EXTERNAL FM
```

## REMOTE OPERATION REMOTE PROGRAMMING

Instrument parameters can be retrieved with a query (programming commands that contain a question mark):

```
200 PRINT @2, "FREQ?"           ! RETRIEVE FREQUENCY
210 INPUT LINE @2, A$
220 PRINT "Frequency is: "; A$
230 PRINT @2, "RFOUT?"         ! RETRIEVE RF OUTPUT STATE
240 INPUT LINE @2, A$
250 PRINT "RF output is: "; A$
260 PRINT @2, "FM?; EXTAC_FM?" ! RETRIEVE DEVIATION & EXTERNAL FM STATE
270 INPUT LINE @2, A$
280 PRINT "FM info is: "; A$
```

After the program has run, the output is:

```
Frequency is 1.000000000E+08,HZ
RF output is ON
FM info is 1.200E+03,HZ;ON
```

Programming errors may be checked by the following sample programs. The Error Available (EAV) bit in the serial poll register may be checked using a serial poll.

```
300 A = SPL(3)                   ! CHECK FOR ERRORS
310 IF (A AND 8) THEN PRINT "There was an error"
320 PRINT @2, "*CLS"             ! CLEAR ERRORS
```

The error and an explanation can be checked as follows. Since errors are accumulated in a queue, the entire queue must be read to retrieve and clear all the errors.

```
400 PRINT @2, "ERROR? EXPLAIN"   ! CHECK FOR ERRORS
410 INPUT @2, A, A$
420 IF (A = 0) THEN GOTO 500      ! NO MORE ERRORS
430 PRINT "Error# :";A, A$       ! PRINT ERROR# AND EXPLANATION
440 GOTO 400
500 END
```

## COMMAND SYNTAX INFORMATION

5A-2.

The following syntax rules apply to all the remote commands. (A command consists of a word by itself or a word followed by one or more parameters.) The rules for parameter syntax are provided first (including proper usage of units), followed by the rules for extra spaces, followed by the rules for terminator usage. A description of how the 6080A/AN processes incoming characters provides the basis for answering other possible questions about syntax. Information about syntax of response messages is also given.

### Parameter Syntax Rules

5A-3.

Many of the remote commands require parameters. Improper use of parameters causes command errors to occur.

General rules for parameter usage are as follows:

1. When a command has more than one parameter, the parameters must be separated by commas.

For example: "MEM\_DIVIDER 1, 25, 30, 48".

2. Numeric parameters may have up to 255 significant digits and their exponents may range from -32000 to +32000. The useful range for 6080A/AN programming is  $\pm 2.2 \text{ E-308}$  to  $\pm 1.8 \text{ E308}$ .
3. Specifying more parameters than allowed by a particular command causes a command error.
4. Null parameters cause a command error (e.g., the adjacent commas in "MEM\_DIVIDER 1, 25, , 48").
5. Expressions, for example "(4+2\*13)", are not allowed as parameters.

Units that are accepted in command parameters are listed in Table 5B-1.

### **Extra Space Characters**

#### **5A-4.**

Table 5B-3 and the remote program examples in this section show commands and their parameters separated by spaces. One space after a command is required. All other spaces are optional. They are shown for clarity in the manual and may be left in or omitted as desired. Extra spaces can be inserted between parameters as desired. Extra spaces within a parameter are generally not allowed, except for between a number and its associated unit.

EXAMPLE	EXPLANATION
FREQ 100 MHZ	Equivalent to "FREQ 100MHZ"
MEM_DIVIDER 1, 25, 30, 48	Equivalent to "MEM_DIVIDER 1,25,30,48"
AMPL -1 2.5 DBM	Invalid; no space allowed in a number
AMPL -12.5 DBM	Correct form for above

Table 5B-3 contains examples for commands whose parameters are not self explanatory. Remote program examples for the Fluke 1722A Instrument Controller are provided at the end of this section.

### **Terminators**

#### **5A-5.**

To signify the end of a response sent to the controller, the 6080A/AN sends a "terminator." The 6080A/AN sends the ASCII character Line Feed (LF) with the EOI control line asserted as the terminator for response messages. The 6080A/AN recognizes the following as terminators when encountered in incoming data:

- The ASCII LF character
- Any ASCII character sent with the EOI control line asserted

The terminator used by the Fluke 1722A Instrument Controller for data it sends to instruments on the IEEE-488 bus is programmable, but its default is LF with EOI.

### **Incoming Character Processing**

#### **5A-6.**

The 6080A/AN processes all incoming data as follows:

1. All data is taken as 7-bit ASCII, the eighth bit (DIO8) is ignored (except the 8-bit data byte portion of the \*PUD and \*DDT parameters).
2. Lower-case or upper-case characters are accepted.

3. ASCII characters whose decimal equivalent is less than 32 (Space) are discarded, except for characters 10 (LF) and 13 (CR) and in the \*PUD and \*DDT command arguments. The \*PUD and \*DDT commands allow all characters in their arguments, and they terminate in a special way.

### Response Message Syntax

5A-7.

In Table 5B-3, responses from the 6080A/AN are described wherever appropriate. In order to know whether to read an integer or a floating-point number, the first entry is "(Integer)" or "(Floating)".

Integers for most controllers or computers are decimal numbers in the range -32768 to 32767. Response elements of this type are labeled as "Integer" in the command tables. Floating-point numbers may be in exponential form, i.e., "1.15E-12". Examples in Table 5B-3 show response formats.

### INPUT BUFFER OPERATION

5A-8.

As the 6080A/AN receives each data byte from the controller, it places the bytes in a portion of memory called the input buffer. The input buffer holds up to 64 data bytes and operates in a first-in/first-out fashion.

The 6080A/AN treats the IEEE-488 EOI control line as a separate data byte and inserts it into the input buffer if it is encountered as part of a message terminator.

The 6080A/AN treats the IEEE-488 trigger interface message as a separate byte and inserts it into the input buffer at the time it is received.

Input buffer operation is transparent to the program running on the controller. If the controller sends commands faster than the 6080A/AN can process them, the input buffer fills to capacity. When the input buffer is full, the 6080A/AN holds off the IEEE-488 bus with the handshake lines. When the 6080A/AN has processed a data byte from the full input buffer, it then completes the handshake, allowing the controller to send another data byte.

The 6080A/AN clears the input buffer at power-on and on receiving the DCL (Device Clear) or SDC (Selected Device Clear) messages from the controller.

### COMMANDS

5A-9.

Table 5B-1 summarizes the commands by function. Table 5B-3 provides protocol details of the remote commands. The commands duplicate almost all activities that can be initiated from the front panel in local operation. Separate headings for each command in the tables provide the parameters and responses (if any), and an example for cases in which the parameters are not self explanatory.

### Multiple Commands

5A-10.

If the controller on the IEEE-488 bus is a Fluke 1722A, commands are sent one at a time, or combined, in Fluke BASIC PRINT statements. For example if the 6080A/AN bus address is 2, use the following BASIC program statements to set the 6080A/AN to output 100 MHz and -25 dBm.

```
10 INIT PORT 0 \ REMOTE @2 ! PUT THE 6080A/AN INTO THE REMOTE STATE
20 PRINT @2,"FREQ 100 MHZ" ! PROGRAM 100 MHZ
30 PRINT @2,"AMPL -25 DBM" ! PROGRAM -25 DBM
40 PRINT @2,"RFOUT ON" ! TURN THE RF OUTPUT ON
```

The same results can be achieved by combining the three commands in one statement as follows (note that each command is separated by a “;”):

```
10 INIT PORT 0 \ REMOTE @2  
20 PRINT @2,"FREQ 100 MHZ ; AMPL -25 DBM ; RFOUT ON"
```

### Command Processing

5A-11.

All commands are processed in the order they are received. Each command is completely processed before the next is processed.

Table 5B-3 lists all the commands processed by the 6080A/AN. Commands are received and executed at all times. Some restrictions may apply in certain 6080A/AN modes of operation.

### Command Restrictions

5A-12.

During sweep operation, some commands are rejected and some are processed differently. This information is noted in Table 5B-3 with the description of the commands.

In local, all calibration and compensation commands are rejected. (CAL\_AM, CAL\_FM, CAL\_LEVEL, CAL\_REFOSC, CMEM\_FIX, COMP\_ATT, COMP\_COARSE, COMP\_OUT, COMP\_OUTDEF, COMP\_SUBSYN, COMP\_SUM)

During calibration and compensation procedures, only a subset of commands are allowed. Refer to the section “Closed-Case Calibration Adjustments” and the section “Compensation Procedures” in the Service Manual for details.

In listen-only, all calibration and compensation commands and all the queries (those that end with a “?”) are rejected.

### Commands That Require the CAL|COMP Switch To Be Set

5A-13.

The following commands do not work unless the rear panel CAL|COMP switch is in the 1 (on) position: \*PUD, CMEM\_FIX, and all commands that start with CAL\_, CC\_, and COMP\_. Attempting to use any of these commands with the CAL|COMP switch in the 0 (off) position causes the 6080A/AN to log an error into the error queue.

### CAUTION

Great care should be exercised in using these commands, as they may alter the 6080A/AN calibration compensation data.

## REMOTE/LOCAL STATE TRANSITIONS

5A-14.

The 6080A/AN can be operated using the front panel keys as described in Section 4, “Front Panel Operation”, or remotely using a remote controller. In addition, the 6080A/AN can be placed in a local lockout condition at any time by command of the controller. When combined, the local, remote, and lockout conditions yield four possible operating states:

- Local

The 6080A/AN responds to local (front panel) and remote remote commands. This is also called “front panel operation.” Some remote commands are not allowed in the local state. These are mostly procedural commands such as the calibration and compensation commands.

- Local with Lockout

Local with lockout is identical to local, except the 6080A/AN will go into the remote with lockout state instead of the remote state when it receives a remote command. The local with lockout state is entered by executing the Fluke 1722A BASIC “LOCKOUT” statement when using the 1722A as an IEEE-488 controller.

- Remote

When the Remote Enable (REN) line is asserted and a controller addresses the 6080A/AN as a listener, it enters the remote state. These conditions are met, for example, when a Fluke 1722A executes the BASIC statement “REMOTE \ PRINT @2 ‘FREQ 100 MHZ’” if the 6080A/AN’s address is 2. In the remote state, the REMOTE annunciator is lit.

Front panel operation is restricted to use of the power switch and the CLR/LCL key. Pressing this key returns the 6080A/AN to the local state. The controller may also send a Go To Local (GTL) interface message. (When the Fluke 1722A is used, the “LOCAL @2” BASIC statement does this if the 6080A/AN’s address is 2.)

- Remote with Lockout

The remote with lockout state can be entered from the remote state or from the local with lockout state, but not directly from the local state. Remote with lockout is similar to the remote state, but it is restricted: the CLR/LCL key does not return the 6080A/AN to the local state. Instead, the message “Loc out” is displayed in the FREQUENCY display field when the key is pressed.

To return the 6080A/AN to the local with lockout state, the controller sends the Go To Local interface message (GTL). (When the Fluke 1722A is used as an IEEE-488 controller, the “LOCAL @2” BASIC statement does this if the 6080A/AN’s address is 2.)

Table 5A-1 summarizes the possible Remote/Local state transitions

Table 5A-1. Remote/Local State Transitions

FROM	TO	USE	FLUKE 1722A BASIC COMMAND
Local	Remote	MLA + REN	REMOTE
	Local/Lockout	LLO + REN	LOCKOUT
Remote	Local	GTL, or CLR/LCL key	LOCAL
	Remote/Lockout	LLO + REN	LOCKOUT
Local/Lockout	Remote/Lockout	MLA + REN	REMOTE, or any 6080A/AN command
Remote/Lockout	Local	REN	LOCAL
	Local/Lockout	GTL	LOCAL @ < address >

#### CHECKING THE INSTRUMENT STATUS

5A-15.

The programmer has access to status registers, enable registers, and queues in the 6080A/AN to indicate various conditions in the 6080A/AN as shown in Figure A-1. Some of the registers and queues are defined by the IEEE-488.2 standard. The rest are specific to the 6080A/AN.

Each status register and queue has a summary bit in the Serial Poll Status Byte. Enable registers are used to mask various bits in the status registers and generate summary bits in the Serial Poll Status Byte. The Service Request Enable Register can be used to assert the IEEE-488 Service Request (SRQ) control line on any one of the status conditions in the instrument.

Queries cause the 6080A/AN response to be placed in the output queue. The output queue may contain responses from more than one query. The responses are output on a first-in/first-out basis, one at a time, in response to a controller input program statement. If the output queue is empty, no response will be sent to the controller.

#### Serial Poll Status Byte (STB)

5A-16.

The most important and frequently used register is the serial poll status byte, which the 6080A/AN sends when it responds to a serial poll. The status byte can also be retrieved with the \*STB? command. The value of this byte at power-on is determined by the value of the service request enable register (SRE), which is saved in non-volatile memory.

#### BIT ASSIGNMENTS FOR THE STB AND SRE

5A-17.

The bits in the Serial Poll Status Byte (STB) and Service Request Enable Register (SRE) are assigned as shown in Figure 5A-2.

**REMOTE OPERATION  
REMOTE PROGRAMMING**

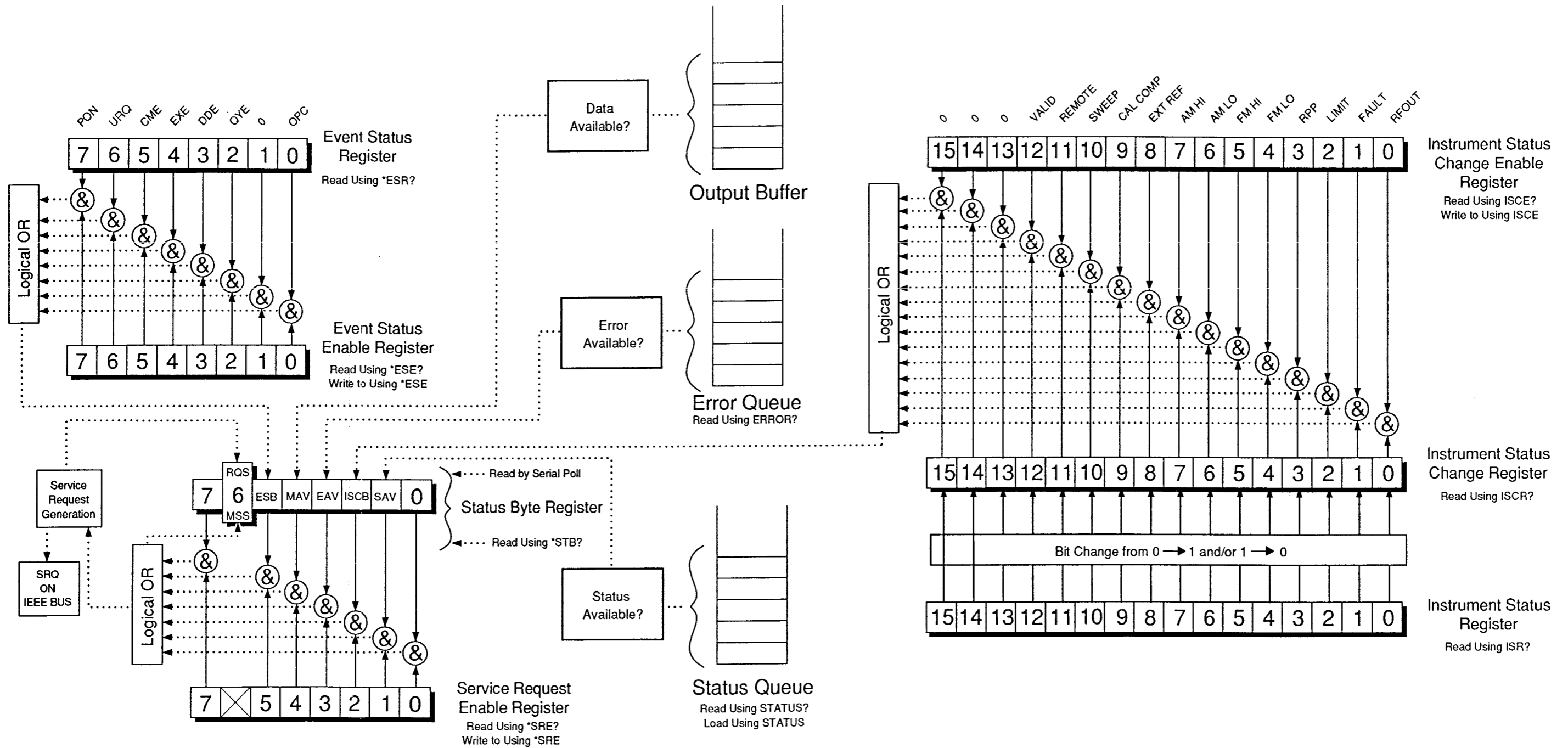

Figure 5A-1. Instrument Status Overview



7	6	5	4	3	2	1	0
0	RQS	ESB	MAV	EAV	ISCB	SAV	0
	MSS						

**RQS** Requesting service. The RQS bit is set to 1 whenever bits ESB, MAV, EAV, ISCB, or SAV change from 0 to 1 and are enabled (1) in the SRE. When RQS is 1, the 6080A/AN asserts the SRQ control line on the IEEE-488 interface. A serial poll to read this bit will determine if the 6080A/AN is the source of an SRQ.

**MSS** Master summary status. Set to 1 whenever bits ESB, MAV, EAV, ISCB, or SAV are 1 and enabled (1) in the SRE. This bit can be read using the \*STB? command.

**ESB** Is set to 1 when one or more enabled ESR bits are 1.

**MAV** Message available. The MAV bit is set to 1 whenever data is available in the 6080A/AN's IEEE-488 interface output buffer.

**EAV** Error available. An error has occurred and an error code is available to be read from the error queue using the ERROR? query.

**ISCB** One or more enabled ISCR bits are 1.

**SAV** Status available. Status codes have been loaded into the status queue and are available to be read from the queue using the STATUS? query.

Figure 5A-2. Bit Assignments for the STB and SRE

SERVICE REQUEST LINE (SRQ)

5A-18.

Service Request (SRQ) is an IEEE-488.1 bus control line that the 6080A/AN asserts to notify the controller that it requires some type of service. Many instruments can be on the bus, but they all share a single SRQ line. To determine which instrument set SRQ, the controller normally does a serial poll of each instrument. The 6080A/AN asserts SRQ whenever the RQS bit in its Serial Poll Status Byte is 1. This bit informs the controller that the 6080A/AN was the source of the SRQ. The front panel SRQ annunciator is lit whenever the 6080A/AN asserts SRQ.

The 6080A/AN clears SRQ and RQS whenever the controller performs a serial poll of the 6080A/AN IEEE-488 interface, sends \*CLS, or whenever the MSS bit is cleared. The MSS bit is cleared only when ESB, MAV, EAV, ISCB, and SAV are 0, or when they are disabled by their associated enable bits in the SRE register being set to 0.

SERVICE REQUEST ENABLE REGISTER (SRE)

5A-19.

The Service Request Enable Register (SRE) enables or masks the bits of the Serial Poll Status Byte. The SRE is stored in non-volatile memory and is restored to its power-off value when the power is turned on.

PROGRAMMING THE STB AND SRE

5A-20.

The SRE can be set with the remote command \*SRE and with a front panel special function sequence.

By setting the bits in the SRE, the associated bits in the Serial Poll Status Byte can be enabled. The following sample program enables the Error Available (EAV) bit.

```

10 ! THIS PROGRAM SETS EAV IN THE SRE
20 GOSUB 100 ! GET AND PRINT OLD SRE
30 IF ((A% AND 16%)=0%) THEN A% = A%+16% ! ENABLE EAV (BIT 4)
40 PRINT @2, "*SRE ";A% ! "
50 GOSUB 100 ! GET AND PRINT NEW SRE
60 END
100 PRINT @2, "**SRE?" ! ASK FOR THE SRE CONTENTS
110 INPUT @2, A% ! RETRIEVE THE REGISTER CONTENTS
120 PRINT "SRE = ";A%
130 RETURN

```

The following key sequence sets the SRE to be 16 (EAV enabled).

ENTER:	DISPLAY SHOWS:	EXPLANATION
<div style="display: flex; gap: 10px;"> <div style="border: 1px solid black; padding: 2px 5px;">SPCL</div> <div style="border: 1px solid black; padding: 2px 5px;">1</div> <div style="border: 1px solid black; padding: 2px 5px;">3</div> </div>	" SrE 12 ?"	Current value
<div style="display: flex; gap: 10px;"> <div style="border: 1px solid black; padding: 2px 5px;">1</div> <div style="border: 1px solid black; padding: 2px 5px;">6</div> </div>	" SrE 16 "	New value

The following program generates an error, and checks the Serial Poll Status Byte. Enable the EAV bit with the examples above.

```

10 ! THIS PROGRAM GENERATES AN ERROR AND CHECKS IT
20 PRINT @2, "FREQ 100 GHZ" ! CAN'T OUTPUT 100 GHZ
30 A% = SPL(4) ! DO A SERIAL POLL
40 IF ((A% AND 144%)=0%) THEN PRINT "EAV and SRQ should have been set"
50 PRINT @2, "STB?" ! RETRIEVE BYTE
60 INPUT @2, A%
70 IF ((A% AND 16%)=0%) THEN PRINT "EAV should have been set"

```

**Event Status Register (ESR)**

5A-21.

The Event Status Register is a two-byte register in which the higher eight bits are always 0, and the lower eight bits except bit 1 represent various conditions of the 6080A/AN. The ESR is cleared (set to 0) when the power is turned on and every time it is read.

**BIT ASSIGNMENTS FOR THE ESR AND ESE**

5A-22.

The bits in the Event Status Register (ESR) and Event Status Enable Register (ESE) are assigned as shown in Figure 5A-3.

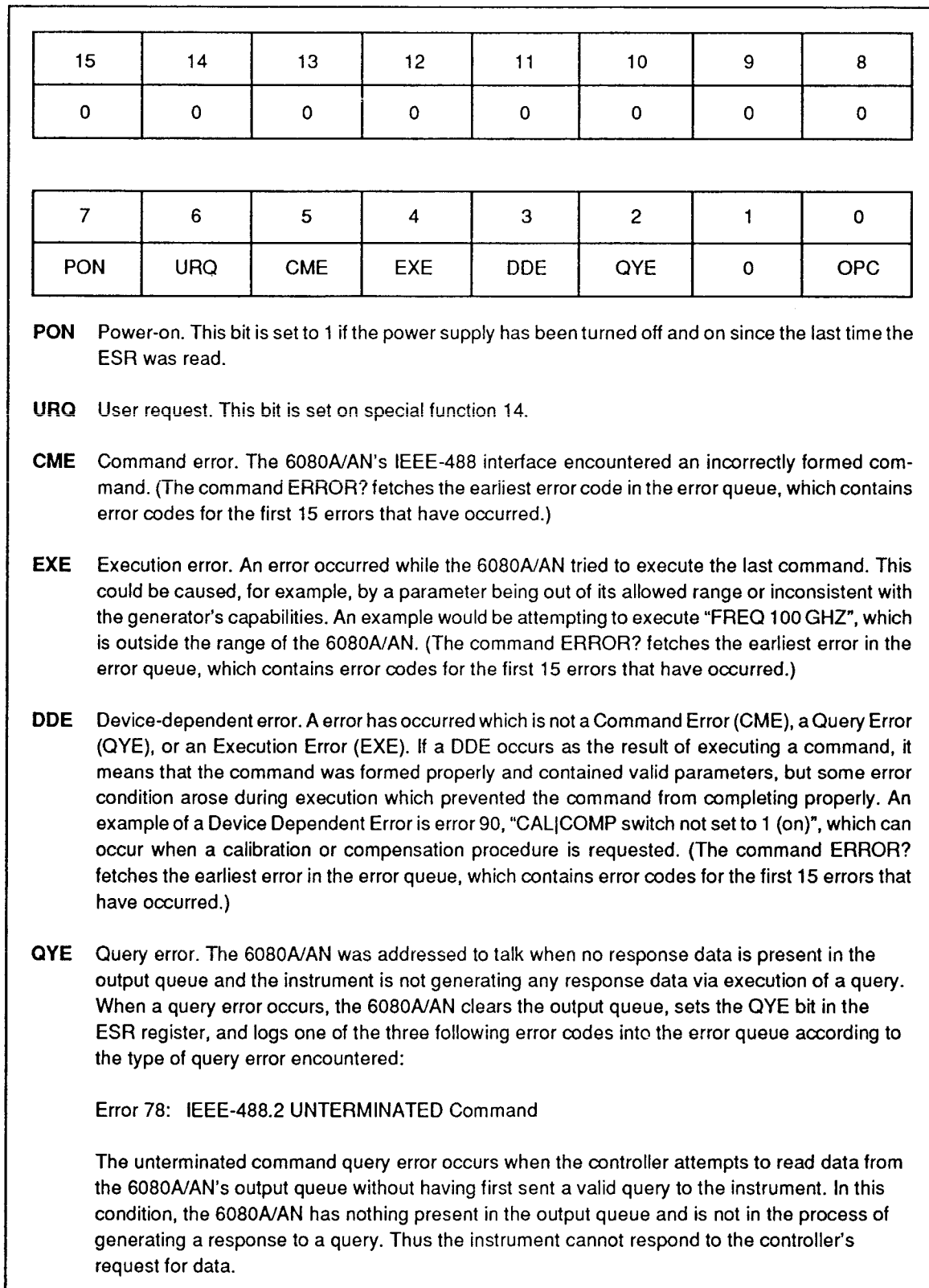

Figure 5A-3. Bit Assignments for ESR and ESE

Error 79: IEEE-488.2 INTERRUPTED Query

Interrupted query occurs when the IEEE-488 controller sends a new character to the 6080A/AN and response data is present in the output queue or the 6080A/AN is generating response data by executing a query. After sending a query to the 6080A/AN, the controller should always be sure to read all of the response data which the generator generates.

Error 80: IEEE-488.2 I/O DEADLOCK

This type of query error occurs when the 6080A/AN has been asked to buffer more data than it has room to store in the output buffer. The 6080A/AN logs this error when the 6080A/AN detects the following three conditions simultaneously:

1. The output buffer is full, thus blocking completion the query which is generating response data.
2. The input buffer is full.
3. The controller is attempting to send a new character to the generator.

If these three conditions occur at the same time, the IEEE-488 bus will be blocked (deadlocked) since the controller cannot clear the condition unless it aborts sending the character and begins reading the output buffer.

**OPC** Operation complete. All commands previous to reception of a \*OPC command have been executed, and the interface is ready to accept another message.

Figure 5A-3. Bit Assignments for ESR and ESE (cont)

EVENT STATUS ENABLE REGISTER (ESE)

5A-23.

A mask register called the Event Status Enable register (ESE) allows the controller to enable or mask (disable) each bit in the ESR. When a bit in the ESE is 1, the corresponding bit in the ESR is enabled. When any enabled bit in the ESR is 1, the ESB bit in the Serial Poll Status Byte also goes to 1. The ESR bit stays 1 until the controller reads the ESR or does a device clear, a selected device clear, or sends the clear status \*CLS command to the 6080A/AN. The ESE is stored in non-volatile memory and is restored when the power is turned on.

PROGRAMMING THE ESR AND ESE

5A-24.

To read the contents of the ESR, send the remote command, \*ESR?. The ESR is cleared (set to 0) every time it is read. To read the contents of the ESE, send the remote command, \*ESE?. The ESE is not cleared when it is read. When either register is read, the 6080A/AN responds by sending a decimal number that represents bits 0 through 15.

The following sample program retrieves the contents of the ESR and ESE registers:

```
10 ! THIS PROGRAM READS THE ESR AND THE ESE REGISTERS
20 PRINT @2, "*ESR?"           ! ASK FOR THE ESR CONTENTS
30 INPUT @2, A%                ! RETRIEVE THE REGISTER CONTENTS
40 PRINT @2, "*ESE?"          ! ASK FOR THE ESE CONTENTS
50 INPUT @2, B%               ! RETRIEVE THE REGISTER CONTENTS
60 PRINT "ESR = ";A%           ! DISPLAY THE ESR REGISTER CONTENTS VALUE
70 PRINT "ESE = ";B%           ! DISPLAY THE ESE REGISTER CONTENTS VALUE
80 END
```

The status of the registers can be read by converting the contents of the variables A% and B% into binary. For example if A% is "32", its binary equivalent is: 00000000 00100000. Therefore, bit 5 (Command Error, CME) in the ESR is set (1) and the rest of the bits are reset (0). This means that the 6080A/AN tried to execute an incorrectly formed command.

By setting the bits in the ESE, the associated bits in the ESR can be enabled. For example, to prevent the occurrence of a command error from causing bit 5 (ESB) in the Serial Poll Status Byte to go to 1, bit 5 in the ESE register can be reset (to 0).

The following sample program accomplishes this by checking the status of the CME bit, then toggling it if it is 1.

```

10 ! THIS PROGRAM RESETS BIT 5 (CME) IN THE ESE
20 PRINT @2,"*ESE 33"           ! INITIAL ESE IS CME + OPC
30 GOSUB 100                    ! GET AND PRINT INITIAL ESE
40 IF (A% AND 32%) THEN A% = A% - 32% ! CLEAR CME (BIT 5)
50 PRINT @2, "*ESE ";A%         ! LOAD THE ESE WITH THE NEW VALUE
60 GOSUB 100                    ! GET AND PRINT NEW ESE
70 END
100 PRINT @2, "**ESE?"          ! ASK FOR THE ESE CONTENTS
110 INPUT @2, A%               ! RETRIEVE THE REGISTER CONTENTS
120 PRINT "ESE = ";A%
130 RETURN

```

The ESE may not be loaded from the front panel.

## Output Queue

5A-25.

The output queue is loaded whenever a query is processed. The controller then reads it with a statement such as the Fluke 1722A BASIC INPUT statement. The Message Available (MAV) bit in the Serial Poll Status Byte indicates whether or not the output queue is empty.

If the queue is empty, the 6080A/AN will not respond to the input statement from the controller.

The output queue is 64 characters long.

## Error Queue

5A-26.

When a command error, execution error, query error, or device-dependent error occurs, its error code is placed in the error queue, where it can be read by the ERROR? command. All error codes are defined in Appendix C of this manual. ERROR? EXPLAIN will return the error code and a description of the error code.

Reading the first error with the ERROR? command removes that error from the queue. A response of "0" means the error queue is empty. The Error Available (EAV) bit in the Serial Poll Status Byte indicates whether or not the error queue is empty. The error queue is cleared when the 6080A/AN is turned on and by the \*CLS command.

The error queue contains up to 16 entries. If many errors occur, only the first 15 errors are kept in the queue. A 16th entry in the queue is always an "error queue overflow" error, and all later errors are discarded until the queue is at least partially read. Since many errors may occur before they are acknowledged and read, the earliest errors are the most likely to point to the problem. Subsequent errors are usually repetitions or consequences of the original problem.

**Instrument Status Register (ISR)**

**5A-27.**

The Instrument Status Register (ISR) gives the controller access to the state of the 6080A/AN, including some of the information presented with the display annunciators on the front panel.

**BIT ASSIGNMENTS FOR THE ISR, ISCR, AND ISCE**

**5A-28.**

The bits in the Instrument Status Register (ISR), Instrument Status Change Register (ISCR), and Instrument Status Change Enable Register (ISCE) are assigned as shown in Figure 5A-4.

**INSTRUMENT STATUS CHANGE REGISTER (ISCR)**

**5A-29.**

The Instrument Status Change Register (ISCR) indicates which ISR bits have changed status (from 0 to 1 or from 1 to 0) since the ISCR was last read. The ISCR is cleared (set to 0) when the 6080A/AN is turned on and every time it is read.

15	14	13	12	11	10	9	8
0	0	0	VALID	REMOTE	SWEEP	CALCOMP	EXTREF
			↑	↑↓	↓	↑↓	↑↓

7	6	5	4	3	2	1	0
AM HI	AM LO	FM HI	FM LO	RPP	LIMIT	FAULT	RFOUT
↑	↑	↑	↑	↑	↑	↑	↑↓

**VALID** When 1, the RF output is valid

**REMOTE** When 1, the 6080A/AN is under remote control (REMOTE annunciator is lit).

**SWEEP** When 1, digital sweep is active.

**CALCOMP** When 1, the CALCOMP switch is in the "1" position.

**EXTREF** When 1, the external reference frequency is being used (EXTREF switch is in the "EXT" position).

**AM HI** When 1, the external AM signal is greater than 1.02V.

**AM LO** When 1, the external AM signal is less than 0.98V.

**FM HI** When 1, the external FM signal is greater than 1.02V.

**FM LO** When 1, the external FM signal is less than .98V.

**RPP** When 1, the RPP circuitry has tripped.

**LIMIT** When 1, the 6080A/AN is operating in a hardware limited region.

**FAULT** When 1, the 6080A/AN has a hardware fault condition.

**RFOUT** When 1, the RF output is on.

**Figure 5A-4. Bit Assignments for the ISR, ISCR, and ISCE**

INSTRUMENT STATUS CHANGE ENABLE REGISTER (ISCE)

5A-30.

The Instrument Status Change Enable Register (ISCE) is a mask register for the ISCR. If a bit in the ISCE is enabled (set to 1) and the corresponding bit in the ISCR changes in the proper direction, the ISCB bit in the Serial Poll Status Byte is set to 1. ISCR bits marked ↑ set the change bit when the ISCR bit goes from a 0 to a 1, ISCR bits marked ↓ set the change bit when the ISCR bit goes from a 1 to a 0, and ISCR bits marked ↑↓ set the change bit when the ISCR bit changes. If all bits in the ISCE are disabled (set to 0), the ISCB bit in the Serial Poll Status Byte never goes to 1. The ISCE is stored in non-volatile memory and is restored to its power-off value when the power is turned on.

PROGRAMMING THE ISR, ISCR, AND ISCE

5A-31.

To read the contents of the ISR, send the remote command, ISR?. To read the contents of the ISCR, send the remote command, ISCR?. To read the contents of the ISCE, send the remote command, ISCE?. The 6080A/AN responds by sending a decimal number that represents bits 0 through 15. Every time the ISCR is read, its contents are zeroed.

The following sample program reads the ISR, ISCR, and ISCE registers:

```

10 ! THIS PROGRAM READS THE ISR, ISCR, AND ISCE REGISTERS
20 ! NOTE THAT THE ICSR? COMMAND ALSO CLEARS THE ISCR CONTENTS
30 PRINT @2, "ISR?" ! ASK THE ISR CONTENTS
40 INPUT @2, A% ! RETRIEVE THE REGISTER CONTENTS FROM THE 6080A/AN
50 PRINT @2, "ISCR?" ! ASK FOR AND CLEAR THE ISCR CONTENTS
60 INPUT @2, B% ! RETRIEVE THE REGISTER CONTENTS FROM THE 6080A/AN
70 PRINT @2, "ISCE?" ! ASK FOR THE ISCE CONTENTS
80 INPUT @2, C% ! RETRIEVE THE REGISTER CONTENTS FROM THE 6080A/AN
90 PRINT "ISR = ";A% ! DISPLAY THE ISR
100 PRINT "ISCR = ";B% ! DISPLAY THE ISCR
110 PRINT "ISCE = ";C% ! DISPLAY THE ISCE
120 END

```

The status of the instrument can be read by converting the returned variables into binary. For example, if a register contains "4", its binary equivalent is: 00000000 00000100. Therefore, bit 3 (CALCOMP) is set (1), and the rest of the bits are reset (0).

By setting the bits in the ISCE, the associated bits in the ISCR can be enabled. For example, to cause an SRQ interrupt when an the RPP trips, bit 3 (RPP) in the ISCE register must be 1. (The ISCB bit must also be enabled in the SRE.)

The following sample program loads a decimal 8 into the ISCE, which sets bit 3 and resets the other bits:

```

10 ! THIS PROGRAM LOADS 00000000 00001000 BINARY INTO THE ISCE
20 PRINT @2, "ISCE 8" ! LOAD DECIMAL 8 INTO THE ISCE
30 PRINT @2, "ISCE?" ! READ BACK THE VALUE
40 INPUT @2, A% ! "
50 PRINT "ISCE = ";A% ! PRINT IT, IT SHOULD BE 8
60 END

```

The ISCE cannot be loaded from the front panel.

**Status Queue**

**5A-32.**

The status queue is loaded with the STATUS command. The argument to the STATUS command (UNCAL, SELFTEST, CHECKSUM, or ORIGIN) indicates which status is to be loaded. The previous contents of the status queue are cleared when a new status is loaded with the STATUS command. Once the status queue is loaded, it can be read with successive STATUS? commands. A response of 0 indicates that the status queue is empty. All status codes are defined in Appendix D and E of this manual. STATUS? EXPLAIN will return the status code and a description of the status code.

Reading the first status with the STATUS? command removes that status from the queue. A response of "0" means the status queue is empty. The Status Available (SAV) bit in the Serial Poll Status Byte is "0" when the status queue is empty and "1" when the queue has been loaded with the STATUS command. The status queue is cleared when the 6080A/AN is turned on and by the \*CLS command.

**IEEE-488 INTERFACE CONFIGURATION**

**5A-33.**

The 6080A/AN IEEE-488 interface supports the IEEE-488 interface function subsets listed in Table 5A-2.

**Table 5A-2. IEEE-488 Interface Function Subsets Supported**

INTERFACE FUNCTION	DESCRIPTION
SH1	Complete source handshake capability
AH1	Complete acceptor handshake capability
T5	Basic talker, serial poll, talk-only mode, Unaddress if MLA
TE0	No extended talker capability
L3	Basic listener operation, listen-only mode, Unaddress if MTA
LE0	No extended listener capabilities
SR1	Full service request capability, with bit-maskable SRQ
RL1	Full remote/local capability, including local lockout
PP0	No parallel poll capability
DC1	Device clear capability
DT1	Device trigger capability
C0	No bus control capability
E2	Tri-state drivers

**BUS COMMUNICATION OVERVIEW**

**5A-34.**

Communication between the controller and the 6080A/AN takes place using commands established by IEEE-488 standards and commands specifically related to the 6080A/AN. The commands in Tables 5B-1 and 5B-3 are all the remote commands, both common and device-dependent. Definitions of the different types of messages used on the IEEE-488 bus follow.

- Device-Dependent Commands

Device-Dependent commands are messages used to transfer information directly between the 6080A/AN and the IEEE-488 controller. Some commands cause an action to take place in the 6080A/AN. Others, called queries in the IEEE standards, ask for information, and always generate a response message from the



instrument. While message format is governed by IEEE-488 standards, messages themselves are unique to the 6080A/AN. For example, device-dependent commands are used to set the RF frequency and amplitude, and to turn the RF output on.

- Common Commands

The IEEE standard 488.2 defines common commands, which are used for functions common to most bus devices. Examples include the command for resetting a device (\*RST) and the query for device identification (\*IDN?). Common commands and queries can be identified easily because they all begin with an asterisk (\*).

- Interface Messages

The IEEE standards define interface messages, which manage the interface system. Some of the interface messages have their own control lines, and others are sent over the data lines by first asserting the control line ATN (Attention). The IEEE-488 hardware within the controller handles interface messages, not the user or application program. For example, when a programming command is sent to the 6080A/AN, the controller automatically sends the interface message MLA (My Listen Address).

### **Definition: Queries and Commands**

### **5A-35.**

Messages directed to the 6080A/AN fall naturally into two categories: commands and queries. Commands (both common command and device-dependent commands) instruct the 6080A/AN to do something or to set a value; no response is expected. Queries generally ask for information from the 6080A/AN, and do not set a value or instruct the instrument to do something; a response is always expected. Some queries also require the 6080A/AN to take action. For example, the \*TST? query has the 6080A/AN do a self test, then send the result to the controller. A query always ends with a question mark. A command never ends with a question mark. Table 5B-3 does not separate commands and queries; they are all called commands and are presented together in one alphabetical list.

All query responses are generated instantly on receipt of the query. In other words, queries generate their output when the 6080A/AN executes the query rather than when the controller attempts to read the response. The 6080A/AN simply generates the requested message and places it in the output queue. When the controller addresses the 6080A/AN as a talker, the contents of the output queue are transmitted to the controller.

Some messages have both query and command forms (e.g., \*PUD and \*PUD?). In such cases, the command generally sets the value of a parameter, and the query generally returns the most recent value of the parameter. Some messages are queries only (e.g., \*IDN?). Some messages are commands only (e.g., \*RST).

### **Functional Elements of Commands**

### **5A-36.**

Table 5A-3 lists the functional elements of commands described by the IEEE-488.2 standard that are used by the 6080A/AN. This table is for those who have a copy of the standard and want to use it to pursue additional information. The standard provides full definitions and syntax diagrams for each element.

Table 5A-3. Functional Elements of Commands

ELEMENT	FUNCTION
PROGRAM MESSAGE	A sequence of zero or more PROGRAM MESSAGE UNIT elements separated by PROGRAM MESSAGE UNIT SEPARATOR elements.
PROGRAM MESSAGE UNIT	A single command, programming data, or query received by the device.
COMMAND MESSAGE UNIT	A single command or programming data received by the device.
QUERY MESSAGE UNIT	A single query sent from the controller to the device.
PROGRAM DATA	Any of the six program data types.
PROGRAM MESSAGE UNIT SEPARATOR	Separates PROGRAM MESSAGE UNIT elements from one another in a PROGRAM MESSAGE.
PROGRAM HEADER SEPARATOR	Separates the header from any associated PROGRAM DATA.
PROGRAM DATA SEPARATOR	Separates sequential PROGRAM DATA elements that are related to the same header.
PROGRAM MESSAGE TERMINATOR	Terminates a PROGRAM MESSAGE.
COMMAND PROGRAM HEADER	Specifies a function or operation. Used with any associated PROGRAM DATA elements.
QUERY PROGRAM HEADER	Similar to a COMMAND PROGRAM HEADER except a query indicator (?) shows that a response is expected from the device.
CHARACTER PROGRAM DATA	A data type suitable for sending short mnemonic data, generally used where a numeric data type is not suitable.
DECIMAL NUMERIC PROGRAM DATA	A data type suitable for sending decimal integers of decimal fractions with or without exponents.
NON-DECIMAL NUMERIC PROGRAM DATA	A data type suitable for sending integer numeric representations in base 16, 8, or 2.
SUFFIX PROGRAM DATA	An optional field following DECIMAL NUMERIC PROGRAM DATA used to indicate associated multipliers and units.
STRING PROGRAM DATA	A data type suitable for sending 7-bit ASCII character strings where the content needs to be "hidden" (by delimiters).
ARBITRARY BLOCK PROGRAM DATA	A data type suitable for sending blocks of arbitrary 8-bit information. Blocks are limited in size to 1024 bytes.

## Interface Messages

5A-37.

Interface messages manage traffic on the bus. Device addressing and clearing, data handshaking, and commands to place status bytes on the bus are all directed by interface messages. Some of the interface messages are communicated by state transitions of dedicated control lines. The rest of the interface messages are sent over the data lines with the ATN signal true. (All device-dependent and common commands are sent over the data lines with the ATN signal false.)

IEEE-488 standards define interface messages. Table 5A-4 lists the interface messages that the 6080A/AN accepts. Table 5A-4 also shows the BASIC statement to execute on the 1722A Controller to generate the interface message. Table 5A-5 lists the interface messages that the 6080A/AN sends. The mnemonics listed in the tables are not sent in BASIC PRINT statements as commands are; in this way they are different from device-dependent and common commands.

Interface messages are handled automatically in most cases. For example, handshake messages DAV, DAC, and RFD automatically occur under the direction of an instrument's interface itself as each byte is sent over the bus.

Table 5A-4. Interface Messages that the 6080A/AN Accepts

MNEMONIC	NAME	FUNCTION	RELATED FLUKE 1722A BASIC COMMAND
ATN	Attention	A control line that, when asserted, notifies all instruments on the bus that the next data bytes are an interface message. When ATN is low, the next data bytes are interpreted as device-dependent or common commands addressed to a specific instrument.	(None)
DAC	Data Accepted	Sets the handshake signal line NDAC low.	(None)
DAV	Data Valid	Asserts the handshake signal line DAV.	(None)
DCL	Device Clear	Clears the input/output buffers.	CLEAR
END	End	A message that occurs when the Controller asserts the EOI signal line before sending a byte.	(None)
GET	Group Execute Trigger	Execute the command string predefined with the *DDT command.	TRIG @
GTL	Go To Local	Transfers control of the 6080A/AN from one of the remote states to one of the local states. (See Table 5A-5.)	LOCAL @
LLO	Local Lockout	Transfers remote/local control of the 6080A/AN. (See Table 5A-5.)	LOCKOUT
IFC	Interface	A control line that sets the interface to a Clear quiescent state.	INIT

**REMOTE OPERATION**  
**REMOTE PROGRAMMING**

**Table 5A-4. Interface Messages that the 6080A/AN Accepts (cont)**

MNEMONIC	NAME	FUNCTION	RELATED FLUKE 1722A BASIC COMMAND
MLA	My Listen Address	Addresses a specific device on the bus as a listener. The controller sends MLA automatically whenever it directs a device-dependent or common command to a specific instrument.	(None)
MTA	My Talk Address	Addresses a specific device on the bus as a talker. The controller sends MTA automatically whenever it directs a device-dependent or common query to a specific instrument.	(None)
REN	Remote Enable	Transfers remote/local control of the 6080A/AN. (See Table 5A-5.)	REMOTE
RFD	Ready for Data	Sets the handshake signal line NRFD low.	(None)
SDC	Selected Device Clear	Does the same thing as DCL, but only if the 6080A/AN is currently addressed as a listener.	CLEAR @
SPD	Serial Poll Disable	Cancels the effect of a Serial Poll Enable.	(Part of SPL)
SPE	Serial Poll Enable	After the 6080A/AN receives this message, it sends the Status Byte the next time it is addressed as a listener, no matter what the command is.	(Part of SPL)
UNL	Unlisten	"Unaddresses" a specific device on the bus as a listener. The controller sends UNL automatically after the device has successfully received a device-dependent or common command.	(None)
UNT	Untalk	"Unaddresses" a specific device on the bus as a talker. The controller sends UNT automatically after it receives the response from a device-dependent or common query.	(None)

Table 5A-5. Interface Messages that the 6080A/AN Sends

MNEMONIC	NAME	FUNCTION
END	End	A message that occurs when the 6080A/AN asserts the EOI control line. The 6080A/AN asserts EOI while it transmits the ASCII character LF for its termination sequence or terminator.
DAC	Data Accepted	Sets the handshake signal line NDAC low.
DAV	Data Valid	Asserts the handshake signal line DAV.
RFD	Ready for Data	Sets the handshake signal line NRFD low.
SRQ	Service Request	A control line that any device on the bus can assert to indicate that it requires attention. Refer to "Checking 6080A/AN Status" for details.
STB	Status Byte	The Status Byte is what the 6080A/AN sends when it responds to a serial poll (interface message SPE).

## THE IEEE-488 CONNECTOR

5A-38.

The IEEE-488 connector on the rear panel mates with an IEEE-488 Standard cable. The pin assignments of the rear-panel IEEE-488 connector are shown in Figure 5A-5.

The IEEE-488 Interface signal SHIELD (pin 12) can be disconnected (when using an IEEE-488 cable without a metallic hood) from the instrument ground. To do this, use the SHIELD switch.

The following restrictions apply to all IEEE-488 systems:

1. A maximum of 15 devices can be connected in a single IEEE-488 bus system.
2. The maximum length of IEEE-488 cable used in one IEEE-488 system is the lesser of either 20 meters or 2 meters times the number of devices in the system.

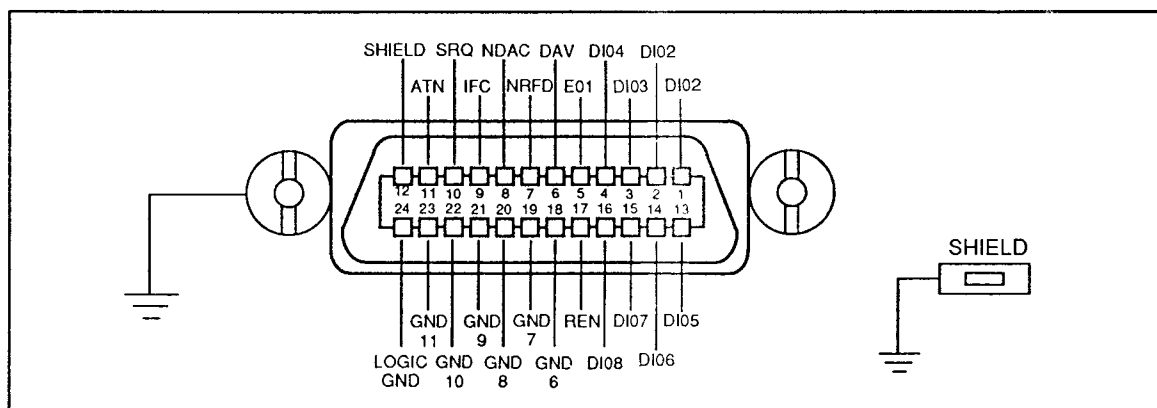

Figure 5A-5. IEEE-488 Connector and Pin Assignments

## REMOTE PROGRAM EXAMPLES

5A-39.

The following programs are written in BASIC for the Fluke 1722A Instrument Controller.

### Using the \*OPC?, \*OPC, and \*WAI Commands

5A-40.

The \*OPC?, \*OPC, and \*WAI commands let the programmer maintain control of the order of execution of commands that could otherwise be passed up by subsequent commands.

If a **FREQ** command has been sent, the output can be checked to see if it has settled by sending the query **\*OPC?**. As soon as the **FREQ** command has completed (output settled), a "1" appears in the output queue. The **\*OPC?** command should always be followed with a read command (for example, in Fluke BASIC, "INPUT @2, A"). The read command causes program execution to pause until the addressed instrument responds.

The following sample program shows how **\*OPC?** can be used.

```
10 PRINT @2, "FREQ 100MHZ;*OPC?"           ! 6080A/AN ADDRESS IS 2
20 INPUT @2, A                             ! READ THE "1" FROM THE 6080A/AN
30 !PROGRAM HALTS HERE UNTIL A "1" IS PUT INTO THE OUTPUT QUEUE
40 PRINT "OUTPUT SETTLED"
```

The **\*OPC** command is similar in operation to the **\*OPC?** query, except that it sets bit 0 (OPC for "Operation Complete") in the Event Status Register to 1 rather than sending a "1" to the output queue. One use for **\*OPC** is to include it in a program so that it generates an SRQ (Service Request). Then an SRQ handler written into the program can detect the operation complete condition and respond appropriately. The **\*OPC** command is similar to **\*OPC?**, except the program must read the ESR to detect the completion of all operations.

The following sample program shows how **\*OPC** can be used.

```
10 REMOTE
20 PRINT @2, "FREQ 100MHZ;*OPC"           ! 6080A/AN ADDRESS IS 2
30 PRINT @2, "**ESR?"                     ! PUT THE ESR BYTE IN BUFFER
40 INPUT @2, A%                          ! READ THE ESR BYTE
50 IF (A% AND 1%) = 0% GOTO 30            ! TRY AGAIN IF NO OPC
60 PRINT "OUTPUT SETTLED"
70 END
```

The **\*WAI** command causes the 6080A/AN to wait until any prior commands have been completed before continuing on to the next command, and takes no other action. Using **\*WAI** is a convenient way to halt controller program execution until the command or commands preceding it have completed.

The following sample program shows how **\*WAI** can be used.

```
10 REMOTE
20 PRINT @2, "FREQ 100MHZ;*WAI"           ! 6080A/AN ADDRESS IS 2
30 PRINT @2, "FREQ?"                     ! READ THE OUTPUT VALUE
40 INPUT @2, A$                          ! A$ CONTAINS THE OUTPUT VALUE
50 PRINT "OUTPUT SETTLED"
60 PRINT "OUTPUT IS: ";A$
70 END
```

## Using the \*DDT and \*TRG Commands

5A-41.

The \*DDT command is used to define the device trigger buffer. Once it is loaded, the stored commands may be executed with the \*TRG command or the Group Execute Trigger (GET) interface message (Fluke 1722A BASIC TRIG command).

The use of the trigger buffer will speed up execution of the application program because the contents of the buffer do not need to be transferred on the IEEE-488 bus each time they are executed.

In the following example, the 6080A/AN is programmed to step frequency approximately every second.

```
10 REMOTE
20 PRINT @2, "FREQ 210 MHZ"      ! 6080A/AN ADDRESS IS 2
30 PRINT @2, "FREQ_STEP 1.25 KHZ" ! PROGRAM STEP SIZE TO 1.25 KHZ
40 PRINT @2, "**DDT #OSTEP_FREQ UP" ! LOAD TRIGGER BUFFER
50 PRINT @2, "**DDT?"           ! VERIFY CONTENTS OF BUFFER
60 INPUT LINE @2, A$ \ PRINT A$ ! A$ SHOULD BE "#213STEP_FREQ UP"
100 TRIG @2                     ! TRIGGER THE 6080A/AN
110 WAIT 1000                   ! WAIT ~1 SECOND
120 GOTO 100                    ! DO IT AGAIN
```





## Section 5B

# Remote Command Tables

### **REMOTE COMMAND SUMMARY**

**5B-1.**

Remote commands, organized by function, are summarized in Table 5B-1. Units that are accepted in command parameters are listed in Table 5B-2.

### **REMOTE COMMANDS**

**5B-2.**

The complete list and description of remote commands, arranged in alphabetical order, is provided in Table 5B-3.

Table 5B-1. Remote Command Summary

RF FREQUENCY	
EXTREF_FREQ	Select the external reference frequency
EXTREF_FREQ?	Retrieve the selected external reference frequency
FREQ	Program the displayed RF frequency
FREQ?	Retrieve the displayed RF frequency
FREQ_ABS?	Retrieve the RF output frequency
FREQ_BASE?	Retrieve the base frequency
FREQ_REL	Select relative frequency mode
FREQ_REL?	Retrieve the state of relative frequency mode
REF?	Retrieve the state of the frequency reference (INT/EXT) selection
RF AMPLITUDE	
AMPL	Program the displayed RF amplitude
AMPL?	Retrieve the displayed RF amplitude
AMPL_ABS?	Retrieve the RF output level
AMPL_BASE?	Retrieve the base amplitude
AMPL_CMPDAT	Select alternate output level compensation data
AMPL_CMPDAT?	Retrieve the alternate output level compensation state
AMPL_COMP	Select the amplitude compensation mode
AMPL_COMP?	Retrieve the state of amplitude compensation mode
AMPL_EMFOUT	Select EMF display mode
AMPL_EMFOUT?	Retrieve the state of EMF display mode
AMPL_RANGE	Select amplitude normal/fixed range mode
AMPL_RANGE?	Retrieve the state of amplitude range mode
AMPL_REL	Select relative amplitude mode
AMPL_REL?	Retrieve the state of relative amplitude mode
AMPL_UNITS	Convert the AMPLITUDE display to specified units
RFOUT	Turn RF OUTPUT port On or Off
RFOUT?	Retrieve the state of the RF OUTPUT port
MODULATION, AM	
AM	Program the AM depth
AM?	Retrieve the AM depth
EXTAC_AM	Turn external AM (AC coupled) On or Off
EXTAC_AM?	Retrieve the state of external AM (AC coupled)
EXTDC_AM	Turn external AM (DC coupled) On or Off
EXTDC_AM?	Retrieve the state of external AM (DC coupled)
INT_AM	Turn internal AM On or Off
INT_AM?	Retrieve the state of internal AM
MODULATION, FM/øM	
EXTAC_FM	Turn external FM/øM (AC coupled) On or Off
EXTAC_FM?	Retrieve the state of external FM/øM (AC coupled)
EXTDC_FM	Turn external DCFM or DCøM On or Off
EXTDC_FM?	Retrieve the state of external DCFM or DCøM
FM	Program the FM/øM deviation
FM?	Retrieve the FM/øM deviation
FM_RANGE	Select normal/low distortion/fixed range FM
FM_RANGE?	Retrieve the state of low distortion/fixed range FM
FM_UNITS	Convert the FM display to specified units
HIRATEPM	Turn high rate øM mode On or Off
HIRATEPM?	Retrieve the state of high rate øM mode

Table 5B-1. Remote Command Summary (cont)

INT_FM	Turn internal FM/ØM On or Off
INT_FM?	Retrieve the state of internal FM/ØM
LORATEFM	Turn low rate FM mode On or Off
LORATEFM?	Retrieve the state of low rate FM mode
<b>MODULATION, PULSE</b>	
EXT_PULSE	Turn external pulse modulation On or Off
EXT_PULSE?	Retrieve the state of external pulse modulation
INT_PULSE	Turn internal pulse modulation On or Off
INT_PULSE?	Retrieve the state of internal pulse modulation
<b>MODULATION, INTERNAL OSCILLATOR</b>	
MOD_WAVE	Select the modulation oscillator waveform
MOD_WAVE?	Retrieve the modulation oscillator waveform
MODF	Program the modulation frequency
MODF?	Retrieve the modulation frequency
MODL	Program the modulation level
MODL?	Retrieve the modulation level
MODOUT	Select the default state of the modulation output port
MODOUT?	Retrieve the default state of the modulation output port
PULSE_WIDTH	Program the modulation oscillator pulse width
PULSE_WIDTH?	Retrieve the modulation oscillator pulse width
<b>SWEEP</b>	
AMPL_MANUAL	Increment or decrement the manual amplitude sweep
AMPL_SINCR	Program the amplitude sweep increment
AMPL_SINCR?	Retrieve the amplitude sweep increment
AMPL_SWIDTH	Program the amplitude sweep width
AMPL_SWIDTH?	Retrieve the amplitude sweep width
FREQ_MANUAL	Increment or decrement the manual frequency sweep
FREQ_SINCR	Program the frequency sweep increment
FREQ_SINCR?	Retrieve the frequency sweep increment
FREQ_SWIDTH	Program the frequency sweep width
FREQ_SWIDTH?	Retrieve the frequency sweep width
SWEEP	Select the sweep mode
SWEEP?	Retrieve the sweep mode
SWEEP_DWELL	Program the sweep dwell time
SWEEP_DWELL?	Retrieve the sweep dwell time
SWEEP_FIELD	Select the sweep field
SWEEP_FIELD?	Retrieve the sweep field
SWEEP_SYM	Select the sweep symmetry
SWEEP_SYM?	Retrieve the sweep symmetry
<b>MISCELLANEOUS</b>	
*DDT	Define device trigger buffer
*DDT?	Query device trigger buffer
DISPLAY	Select the display status
DISPLAY?	Retrieve the display status
GAL	Go to alternate language
KEY_RATE	Select the repeat rate for the step keys
KEY_RATE?	Retrieve the key repeat rate
KNOB_STEP	Select the operation of the knob and step up/down keys

Table 5B-1. Remote Command Summary (cont)

<b>KNOB_STEP?</b> <b>LOCALERT</b> <b>LOCALERT?</b> <b>MOD_DISPLAY</b> <b>MOD_DISPLAY?</b> <b>*OPC</b> <b>*OPC?</b> <b>*OPT?</b> <b>PRESET</b> <b>*PUD</b> <b>*PUD?</b> <b>SPCL</b> <b>*RST</b> <b>*TRG</b> <b>*WAI</b>	Retrieve the state of the knob and step up/down keys Set mode to generate an SRQ on complete front panel operations Retrieve the state of the local alert (LOCALERT) mode Select the quantity to be shown in the modulation field Retrieve the quantity shown in the modulation field Sets bit 0 in the ESR when pending remote operations are complete Reply with "1" when all pending operations are complete Retrieve report of installed options Reset instrument to preset state Define protected user data buffer Retrieve protected user data buffer Select a special function by number Reset instrument to default memory location Trigger device Wait until all pending remote operations are complete
<b>MEMORY</b>	
<b>MEM_DIVIDER</b> <b>MEM_DIVIDER?</b> <b>MEM_LOCK</b> <b>MEM_LOCK?</b> <b>MEM_RESET</b> <b>*RCL</b> <b>*SAV</b> <b>SEQ</b>	Program memory divider locations Retrieve memory divider locations Select lock protection for memory store Retrieve the state of memory lock protection Reset all memory locations to instrument default Recall a memory location Save to a memory location Recall the next or previous memory location
<b>STEP</b>	
<b>AM_STEP</b> <b>AM_STEP?</b> <b>AMPL_STEP</b> <b>AMPL_STEP?</b> <b>FM_STEP</b> <b>FM_STEP?</b> <b>FREQ_STEP</b> <b>FREQ_STEP?</b> <b>MODF_STEP</b> <b>MODF_STEP?</b> <b>MODL_STEP</b> <b>MODL_STEP?</b> <b>SD</b> <b>STEP_AM</b> <b>STEP_AMPL</b> <b>STEP_FIELD</b> <b>STEP_FIELD?</b> <b>STEP_FM</b> <b>STEP_FREQ</b> <b>STEP_MODF</b> <b>STEP_MODL</b> <b>SU</b>	Program the AM depth step size Retrieve the AM depth step size Program the output amplitude step size Retrieve the output amplitude step size Program the FM/ØM deviation step size Retrieve the FM/ØM deviation step size Program the output frequency step size Retrieve the output frequency step size Program the modulation frequency step size Retrieve the modulation frequency step size Program the modulation level step size Retrieve the modulation level step size Step the active step field down by one step size Step the AM depth up or down by one step size Step the output amplitude up or down by one step size Program step field Retrieve step field Step the FM/ØM deviation up or down by one step size Step the output frequency up or down by one step size Step the modulation frequency up or down by one step size Step the modulation level up or down by one step size Step the active step field up by one step size

Table 5B-1. Remote Command Summary (cont)

EDIT	
AM_BRT	Move bright digit to specified decade in AM field
AM_BRT?	Retrieve decade of AM bright-digit position
AMPL_BRT	Move bright digit to specified decade in amplitude field
AMPL_BRT?	Retrieve decade of amplitude bright-digit position
BRT_FIELD	Program bright-digit field
BRT_FIELD?	Retrieve current bright-digit field
EDIT_AM	Select AM bright-digit field and edit AM
EDIT_AMPL	Select amplitude bright-digit field and edit amplitude
EDIT_FM	Select FM/PhiM bright-digit field and edit FM/PhiM
EDIT_FREQ	Select frequency bright-digit field and edit frequency
EDIT_MODF	Select modulation freq bright-digit field and edit modulation freq
EDIT_MODL	Select modulation level bright-digit field and edit modulation level
FM_BRT	Move bright digit to specified decade in FM/PhiM field
FM_BRT?	Retrieve decade of FM/PhiM bright-digit position
FREQ_BRT	Move bright digit to specified decade in frequency field
FREQ_BRT?	Retrieve decade of frequency bright-digit position
MODF_BRT	Move bright digit to specified decade in modulation freq field
MODF_BRT?	Retrieve decade of modulation frequency bright-digit position
MODL_BRT	Move bright digit to specified decade in modulation level field
MODL_BRT?	Retrieve decade of modulation level bright-digit position
STATUS/ERROR	
*CLS	Clear status
ERROR?	Retrieve an error code from the error queue
*ESE	Program Event Status Enable register
*ESE?	Retrieve Event Status Enable register
*ESR?	Retrieve and clear the Event Status Register
EXPLAIN?	Explain a status/error code
*IDN?	Retrieve instrument identification.
ISCE	Program Instrument Status Change Enable register
ISCE?	Retrieve Instrument Status Change Enable register
ISCR?	Retrieve and clear Instrument Status Change Register
ISR?	Retrieve and clear Instrument Status Register
*SRE	Program Service Request Enable register
*SRE?	Retrieve Service Request Enable register
STATUS	Load specified status into the status queue
STATUS?	Retrieve a status code from the status queue
*STB?	Retrieve the status byte
SERVICE	
ATT_LOG?	Retrieve the attenuator log
CAL_AM	Initiate AM calibration procedure
CAL_FM	Initiate FM calibration procedure
CAL_LEVEL	Initiate level calibration procedure
CAL_REFOSC	Initiate reference oscillator calibration procedure
CC_ERRFREQ?	Returns frequency where automatic compensation procedure failed
CC_EXIT	Exit calibration/compensation procedure
CC_FREQ?	Retrieve the RF output frequency during calibration/compensation procedure
CC_RDAM	Report measured AM depth to calibration procedure
CC_RDDVM	Report measured voltage to compensation procedure
CC_RDFM	Report measured FM deviation to calibration procedure
CC_RDFREQ	Report measured RF frequency to calibration procedure

**REMOTE OPERATION**  
**REMOTE COMMAND TABLES**

**Table 5B-1. Remote Command Summary (cont)**

<b>CC_RDPOWER</b>	Report measured power to cal/comp procedure
<b>CC_SAVE</b>	Calculate corrections, save new data in cal/comp memory
<b>CC_TARGET?</b>	Return target value of compensation procedure
<b>CMEM_FIX</b>	Repair compensation memory checksum errors
<b>COMP_ATT</b>	Initiate attenuator compensation procedure
<b>COMP_COARSE</b>	Initiate automatic coarse loop compensation procedure
<b>COMP_OUT</b>	Initiate output compensation procedure
<b>COMP_OUTDEF</b>	Initiate output compensation procedure with default
<b>COMP_SUBSYN</b>	Initiate subsynthesizer compensation procedure
<b>COMP_SUM</b>	Initiate automatic sum loop compensation procedure
<b>ETIME?</b>	Retrieve the elapsed time
<b>TEST_ATT</b>	Program alternate attenuator settings
<b>TEST_DISP</b>	Execute display test
<b>*TST?</b>	Execute self-test

**Table 5B-2. Units Used with Remote Commands**

<b>UNIT</b>	<b>DESCRIPTION</b>
HZ	Frequency, hertz
KHZ	Frequency, kilohertz
MHZ	Frequency, megahertz
MAHZ	Frequency, megahertz
GHZ	Frequency, gigahertz
V	Voltage (amplitude), volts
MV	Voltage (amplitude), millivolts
UV	Voltage (amplitude), microvolts
NV	Voltage (amplitude), nanovolts
DBMV	Voltage (amplitude), decibels referenced to 1 millivolt
DBUV	Voltage (amplitude), decibels referenced to 1 microvolt
DB	Ratio, decibels
DBM	Power (amplitude), decibels referenced to 1 milliwatt
DBMW	Power (amplitude), decibels referenced to 1 milliwatt
DBF	Power (amplitude), decibels referenced to 1 femtowatt
DBFW	Power (amplitude), decibels referenced to 1 femtowatt
PCT	Ratio (AM depth), percent
%	Ratio (AM depth), percent
RAD	Angle (ØM phase), radians
S	Time, seconds
MS	Time, milliseconds
US	Time, microseconds

Table 5B-3. Remote Commands

**AM**

Description: Program the AM depth in percent. The default units are PCT.  
 Parameter: AM depth with optional PCT or % units.  
 Examples: AM 63.2 PCT  
 AM 63.2 %  
 Restrictions: Rejected during manual or single sweep.

**AM?**

Description: Retrieve the AM depth.  
 Parameter: None  
 Responses: 1. (Float) AM depth.  
 2. (String) PCT  
 Example: 6.320E+01,PCT

**AM\_BRT**

Description: Move the bright digit to specified decade in AM field. The default units are PCT.  
 Parameter: Bright-digit decade in AM display with optional PCT or % units.  
 Examples: AM\_BRT 1 PCT  
 AM\_BRT 1 %  
 Restrictions: Rejected during manual or single sweep.

**AM\_BRT?**

Description: Retrieve the decade of AM bright-digit position.  
 Parameter: None  
 Response: 1. (Float) Bright-digit decade in AM display.  
 2. (String) PCT  
 Example: 1.0E+0,PCT

**AM\_STEP**

Description: Program the AM depth step size in percent. The default units are PCT.  
 Parameter: AM depth step size with optional PCT or % units.  
 Restrictions: Rejected during manual or single sweep.

**AM\_STEP?**

Description: Retrieve the AM depth step size.  
 Parameter: None  
 Response: 1. (Float) AM depth step size.  
 2. (String) PCT

Table 5B-3. Remote Commands (cont)

<b>AMPL</b>	
Description:	Program the displayed RF amplitude in dBm, dB $\mu$ V, dBmV, dBf, dB, or V. Default units are DBM. If REL_AMPL is OFF, this is the output RF level. Refer to Section 4B, "RF Amplitude" for more details. If Auto Amplitude Sweep is active, programs the center Amplitude. Refer to Section 4E, "Sweep" for more information.
Parameter:	Displayed RF amplitude with optional power, voltage, or DB units.
Examples:	AMPL 174 MV AMPL -10.0
Restrictions:	Rejected during manual or single sweep.
<b>AMPL?</b>	
Description:	Retrieve the displayed RF amplitude. If REL_AMPL is OFF, this is the output RF level. If Amplitude Sweep is active, returns the center Amplitude. Refer to section 4E, "Sweep" for more information.
Parameter:	None
Responses:	1. (Float) Displayed RF amplitude. 2. (String) DBM, DBUV, DBMV, DBF, V, DBUV-EMF, DBMV-EMF, or V-EMF
Examples:	1.7400E-01,V -1.0000E+01,DBM
<b>AMPL_ABS?</b>	
Description:	Retrieve the RF output level.
Parameter:	None
Responses:	1. (Float) Output RF amplitude. 2. (String) DBM, DBUV, DBMV, DBF, V, DBUV-EMF, DBMV-EMF, or V-EMF
<b>AMPL_BASE?</b>	
Description:	Retrieve the base amplitude. If AMPL_REL is OFF, this value is 0 dB. Refer to Section 4B, "RF Amplitude" for more details.
Parameter:	None
Responses:	1. (Float) Base RF amplitude. 2. (String) DB, V, or V-EMF
<b>AMPL_BRT</b>	
Description:	Move the bright digit to specified decade in amplitude field. Note that the units must match the displayed units (e.g. V, MV, UV or NV for Volts; DBM, DBUV, DBMV, or DBF for dB) when specifying the bright-digit position. The default units are DBM.
Parameter:	Bright-digit decade in AMPLITUDE display field with optional power, voltage, or DB units.
Examples:	AMPL_BRT 10 UV AMPL_BRT .1 DBM
Restrictions:	Rejected during manual or single sweep.



Table 5B-3. Remote Commands (cont)

<b>AMPL_BRT?</b>	
Description:	Retrieve the decade of amplitude bright-digit position.
Parameter:	None
Responses:	1. (Float) Bright-digit decade in AMPLITUDE display field. 2. (String) DBM, DBUV, DBMV, DB, or V
Example:	1.0E-7,V
<b>AMPL_CMPDAT</b>	
Description:	Select standard or alternate output level compensation data.
Parameter:	STD or ALT
Restrictions:	Rejected during sweep.
<b>AMPL_CMPDAT?</b>	
Description:	Retrieve the output level compensation state.
Response:	(String) STD or ALT
<b>AMPL_COMP</b>	
Description:	Select the amplitude compensation mode.
Parameter:	ALL or OUTPUT or NONE
Restrictions:	Rejected during sweep.
<b>AMPL_COMP?</b>	
Description:	Retrieve the state of amplitude compensation mode.
Parameter:	None
Response:	(String) ALL or OUTPUT or NONE
<b>AMPL_EMFOUT</b>	
Description:	Select EMF output mode.
Parameter:	ON or OFF
Restrictions:	Rejected during sweep.
<b>AMPL_EMFOUT?</b>	
Description:	Retrieve the state of EMF output mode.
Parameter:	None
Response:	(String) ON or OFF
<b>AMPL_MANUAL</b>	
Description:	Increment or decrement the active manual amplitude sweep by specified number of counts. Note that the sign of sweep width affects the outcome of this operation.
Parameter:	Number of counts to increment or decrement the active manual amplitude sweep.
Restrictions:	Only allowed during manual amplitude sweep.

Table 5B-3. Remote Commands (cont)

<b>AMPL_RANGE</b>	
Description:	Select amplitude range mode.
Parameter:	NORMAL or FIXED
Restrictions:	Rejected during sweep.
<b>AMPL_RANGE?</b>	
Description:	Retrieve the state of amplitude range mode.
Parameter:	None
Response:	(String) NORMAL or FIXED
<b>AMPL_REL</b>	
Description:	Select relative amplitude mode. Refer to Section 4B, "RF Amplitude" for more details.
Parameter:	ON or OFF
Restrictions:	Rejected during sweep.
<b>AMPL_REL?</b>	
Description:	Retrieve the state of relative amplitude mode.
Parameter:	None
Response:	(String) ON or OFF
<b>AMPL_SINCR</b>	
Description:	Program the amplitude sweep increment in dB or V. The default units are DB.
Parameter:	Increment with optional DB units or voltage units.
Restrictions:	Rejected during manual or single sweep.
<b>AMPL_SINCR?</b>	
Description:	Retrieve the amplitude sweep increment.
Parameter:	None
Responses:	1. (Float) Amplitude sweep increment. 2. (String) DB, V, or V-EMF
<b>AMPL_STEP</b>	
Description:	Program the amplitude step size in dB or V. The default units are DB.
Parameter:	Amplitude step size with optional DB units or voltage units.
Restrictions:	Rejected during manual or single sweep.
<b>AMPL_STEP?</b>	
Description:	Retrieve the amplitude step size.
Parameter:	None
Responses:	1. (Float) Amplitude step size. 2. (String) DB, V, or V-EMF

Table 5B-3. Remote Commands (cont)

<b>AMPL_SWIDTH</b>	
Description:	Program the amplitude sweep width in dB or V. The default units are DB. Note that a negative value will cause a sweep from a higher power level to a lower one.
Parameter:	Sweep width with optional DB units or voltage units.
Example:	AMPL_SWIDTH -1.820E-6 V AMPL_SWIDTH 10.2 DB AMPL_SWIDTH 2
Restrictions:	Rejected during manual or single sweep.
<b>AMPL_SWIDTH?</b>	
Description:	Retrieve the amplitude sweep width.
Parameter:	None
Responses:	1. (Float) Amplitude sweep width. 2. (String) DB, V, or V-EMF
<b>AMPL_UNITS</b>	
Description:	Convert the AMPLITUDE display to specified units.
Parameter:	DBM or V
Restrictions:	Rejected during sweep.
<b>ATT_LOG?</b>	
Description:	Retrieve the attenuator log.
Parameter:	None
Responses:	1. (Integer) A6 attenuator count. 2. (Integer) A12 attenuator count. 3. (Integer) A24A attenuator count. 4. (Integer) A24B attenuator count. 5. (Integer) A24C attenuator count. 6. (Integer) A24D attenuator count. 7. (Integer) A24E attenuator count.
Example:	1470,1180,641,627,607,587,577
<b>BRT_FIELD</b>	
Description:	Move the bright digit to the specified field.
Parameter:	AM or AMPL or FM or FREQ or MODF or MODL
Restrictions:	Rejected during manual or single sweep.
<b>BRT_FIELD?</b>	
Description:	Retrieve the current bright-digit field.
Parameter:	None
Response:	(String) AM or AMPL or FM or FREQ or MODF or MODL

Table 5B-3. Remote Commands (cont)

<b>CAL_AM</b>	
Description:	Initiate AM calibration procedure. Note that the rear panel CAL COMP switch must be set to 1 (on).
Parameter:	None
Restrictions:	Rejected during a calibration or compensation procedure, or during sweep.
<b>CAL_FM</b>	
Description:	Initiate FM calibration procedure. Note that the rear panel CAL COMP switch must be set to 1 (on).
Parameter:	None
Restrictions:	Rejected during a calibration or compensation procedure, or during sweep.
<b>CAL_LEVEL</b>	
Description:	Initiate level calibration procedure. Note that the rear panel CAL COMP switch must be set to 1 (on).
Parameter:	None
Restrictions:	Rejected during a calibration or compensation procedure, or during sweep.
<b>CAL_REFOSC</b>	
Description:	Initiate reference oscillator calibration procedure. Note that the rear panel CAL COMP switch must be set to 1 (on).
Parameter:	None
Restrictions:	Rejected during a calibration or compensation procedure, or during sweep.
<b>CC_ERRFREQ?</b>	
Description:	Returns error code and frequency where automatic comp procedure failed. If no errors were generated, a zero is returned for both the error code and frequency responses.
Parameter:	None
Responses:	1. (Integer) Error Code 2. (Float) Frequency 3. (String) HZ
<b>CC_EXIT</b>	
Description:	Exit calibration/compensation procedure.
Parameter:	None
Restrictions:	Only allowed when performing a calibration or compensation procedure.

Table 5B-3. Remote Commands (cont)

<b>CC_FREQ?</b>	
Description:	Retrieve the RF output frequency during calibration/ compensation procedure.
Parameter:	None
Responses:	1. (Float) Output frequency 2. (String) HZ
Restrictions:	Only allowed when performing a calibration procedure or attenuator, output, or subsynthesizer compensation procedure.
<b>CC_HETADJ?</b>	
Description:	Returns Het band frequency and level adjustment where Het level adjustment can be made following an unsuccessful output compensation procedure. If no output compensation procedure has been performed since poweron, a zero is returned for both the frequency and adjustment responses.
Parameter:	None
Responses:	1. (Float) Frequency 2. (String) HZ 3. (Float) Level Adjustment 4. (String) DB
<b>CC_RDAM</b>	
Description:	Report measured AM depth to calibration procedure. Default units are PCT.
Parameter:	AM depth with optional PCT or % units.
Restrictions:	Only allowed when performing an AM calibration procedure.
<b>CC_RDDVM</b>	
Description:	Report measured voltage to compensation procedure. Default units are V.
Parameter:	Voltage with optional voltage units.
Restrictions:	Only allowed when performing a sub-synthesizer compensation procedure.
<b>CC_RDFM</b>	
Description:	Report measured FM deviation to calibration procedure. Default units are HZ.
Parameter:	FM deviation with optional frequency units.
Restrictions:	Only allowed when performing an FM calibration procedure.
<b>CC_RDFREQ</b>	
Description:	Report measured RF frequency to calibration procedure. Default units are HZ.
Parameter:	Frequency with optional frequency units.
Restrictions:	Only allowed when performing a reference oscillator calibration procedure.
<b>CC_RDPOWER</b>	
Description:	Report measured power to calibration/compensation procedure. Default units are DBM.
Parameter:	Output power with optional DBM units.
Restrictions:	Only allowed when performing a level calibration or attenuator or output compensation procedure.

Table 5B-3. Remote Commands (cont)

<b>CC_SAVE</b>	
Description:	Calculate corrections, save new data in calibration/compensation memory. Note that the rear panel CAL COMP switch must be set to 1 (on).
Parameter:	None
Restrictions:	Only allowed when performing a calibration procedure or attenuator, output, or subsynthesizer compensation procedure.
<b>CC_TARGET?</b>	
Description:	Return target value of calibration/compensation procedure.
Parameter:	None
Responses:	1. (Float): Target value. 2. (String) PCT, HZ, DBM, or V
Restrictions:	Only allowed when performing a calibration procedure or attenuator, output, or subsynthesizer compensation procedure.
<b>*CLS</b>	
Description:	Clear status. Clears the ESR, the ISCR, and the error and status queues. Terminates a pending operation complete command (*OPC or *OPC?).
Parameter:	None
<b>CMEM_FIX</b>	
Description:	Repair calibration/compensation memory checksum errors. Note that the rear panel CAL COMP switch must be set to 1 (on).
Parameter:	None
Restrictions:	Rejected during a calibration or compensation procedure, or during sweep.
<b>COMP_ATT</b>	
Description:	Initiate attenuator compensation procedure. Note that the rear panel CAL COMP switch must be set to 1 (on).
Parameter:	None
Restrictions:	Rejected during a calibration or compensation procedure, or during sweep.
<b>COMP_COARSE</b>	
Description:	Initiate automatic coarse loop compensation procedure. Note that the rear panel CAL COMP switch must be set to 1 (on).
Parameter:	None
Restrictions:	Rejected during a calibration or compensation procedure, or during sweep.
<b>COMP_OUT</b>	
Description:	Initiate output compensation procedure. Note that the rear panel CAL COMP switch must be set to 1 (on).
Parameter:	None
Restrictions:	Rejected during a calibration or compensation procedure, or during sweep.

Table 5B-3. Remote Commands (cont)

<b>COMP_OUTDEF</b>	<p>Description: Initiate output compensation procedure with default attenuator through-path corrections applied. Note that the rear panel CAL COMP switch must be set to 1 (on).</p> <p>Parameter: None</p> <p>Restrictions: Rejected during a calibration or compensation procedure, or during sweep.</p>
<b>COMP_SUBSYN</b>	<p>Description: Initiate subsynthesizer compensation procedure. Note that the rear panel CAL COMP switch must be set to ON.</p> <p>Parameter: None</p> <p>Restrictions: Rejected during a calibration or compensation procedure, or during sweep.</p>
<b>COMP_SUM</b>	<p>Description: Initiate automatic sum loop compensation procedure. Note that the rear panel CAL COMP switch must be set to 1 (on).</p> <p>Parameter: None</p> <p>Restrictions: Rejected during a calibration or compensation procedure, or during sweep.</p>
<b>*DDT</b>	<p>Description: Define device trigger. Used to load commands into the device trigger buffer for subsequent execution when a *TRG common command or the group execute trigger (GET) IEEE-488.1 interface message is received. The syntax of the data loaded is not checked until the trigger command is received. A *TRG command in the trigger buffer will cause an Execution Error when the trigger command is received.</p> <p>Parameter: #0&lt;user data&gt;&lt;ASCII Line Feed with EOI&gt; or #&lt;non-zero digit&gt;&lt;digits&gt;&lt;user data&gt;</p> <p>For both forms, the bytes received in the &lt;user data&gt; field are stored in non-volatile memory and up to 72 bytes are allowed. The first form accepts data bytes after the #0 until the ASCII Line Feed character is received with an EOI signal.</p> <p>In the second form, the non-zero digit specifies the number of characters that will follow in the &lt;digits&gt; field. These characters must be 0 through 9 (ASCII 48 through 57 decimal). The value of the number in the &lt;digits&gt; field defines the number of user data bytes that will follow in the &lt;user data&gt; field.</p> <p>Examples: *DDT #0STEP_FREQ UP&lt;Line Feed with EOI&gt; or *DDT #212STEP_FREQ UP</p> <p style="text-align: center;"><b>NOTE</b></p> <p>The 2 indicates that there are two digits to follow (in this case "12"), and the 12 indicates that there are twelve characters in the remainder of the *DDT message (in this case, "STEP_FREQ UP").</p>

Table 5B-3. Remote Commands (cont)

<b>*DDT?</b>	
Description:	Retrieves the contents of the *DDT (Define Device Trigger) buffer.
Parameter:	None
Response:	#(non-zero digit)(digits)(user data)  The non-zero digit specifies the number of characters that will follow in the <digits> field. These characters are 0 through 9 (ASCII 48 through 57 decimal). The value of the number in the <digits> field defines the number of user data bytes that follow in the <user data> field. The maximum response is 72 characters.
Example:	#212STEP_FREQ UP
<b>DISPLAY</b>	
Description:	Select the display status.
Parameter:	ON or OFF
Restrictions:	Rejected during sweep.
<b>DISPLAY?</b>	
Description:	Retrieve the display status.
Parameter:	None
Response:	(String) ON or OFF
<b>EDIT_AM</b>	
Description:	Select the AM bright-digit field and edit AM by the specified number of counts.
Parameter:	Number of counts by which bright digit is edited.
Example:	AM_BRT 1 PCT; EDIT_AM -18
Restrictions:	Rejected during manual or single sweep.
<b>EDIT_AMPL</b>	
Description:	Select the amplitude bright-digit field and edit amplitude by the specified number of counts.
Parameter:	Number of counts by which bright digit is edited.
Example:	EDIT_AMPL 293
Restrictions:	Rejected during manual or single sweep.
<b>EDIT_FM</b>	
Description:	Select the FM bright-digit field and edit FM by the specified number of counts.
Parameter:	Number of counts by which bright digit is edited.
Restrictions:	Rejected during manual or single sweep.



Table 5B-3. Remote Commands (cont)

<b>EDIT_FREQ</b>	
Description:	Select the frequency bright-digit field and edit frequency by the specified number of counts.
Parameter:	Number of counts by which bright digit is edited.
Example:	FREQ_BRT 1 HZ; EDIT_FREQ 172
Restrictions:	Rejected during manual or single sweep.
<b>EDIT_MODF</b>	
Description:	Select the modulation frequency bright-digit field and edit modulation frequency by the specified number of counts.
Parameter:	Number of counts by which bright digit is edited.
Restrictions:	Rejected during manual or single sweep.
<b>EDIT_MODL</b>	
Description:	Select the modulation level bright-digit field and edit modulation level by the specified number of counts.
Parameter:	Number of counts by which bright digit is edited.
Restrictions:	Rejected during manual or single sweep.
<b>ERROR?</b>	
Description:	Retrieve earliest error code from the error queue. If no error codes are pending, a zero is returned. If the optional keyword EXPLAIN is specified, a character string containing its explanation is returned with the error code.
Parameter:	(optional) EXPLAIN
Examples:	FREQ 100 GHZ; ERROR? EXPLAIN
	Returns: 1, "Frequency out of range"
	FREQ 100 GHZ; ERROR?
	Returns: 1
Responses:	1. (Integer) The error code. 2. (optional) (String) The explanation of the code.
<b>*ESE</b>	
Description:	Loads a byte into the Event Status Enable Register, described under "Checking the Instrument Status".
Parameter:	The decimal equivalent of the binary number to load into the register (0-255 only).
Example:	*ESE 140
	Enables bits 2 (QYE), 3 (DDE), and 7 (PON), and disables all the other bits. (See "Checking the Instrument Status" for details.)

Table 5B-3. Remote Commands (cont)

<b>*ESE?</b>	Description:	Retrieves the byte from the Event Status Enable register, described under "Checking the Instrument Status".
	Parameter:	None
	Response:	(Integer) Decimal equivalent of the register byte.
	Example:	*ESE?  Returns: "140" if bits 2 (QYE), 3 (DDE), and 7 (PON) are enabled (1) and the rest of the bits are disabled (0). (See "Checking the Instrument Status" for details.)
<b>*ESR?</b>	Description:	Retrieve the byte from the Event Status Register and clears the register. The ESR is described under "Checking the Instrument Status".
	Parameter:	None
	Response:	(Integer) Decimal equivalent of the register byte.
	Example:	*ESR?  Returns: "140" if bits 2 (QYE), 3 (DDE), and 7 (PON) are set (1) and the rest of the bits are reset (0). (See "Checking the Instrument Status" for details.)
<b>ETIME?</b>	Description:	Retrieve the elapsed time. This gives the time (with tenths-of-hours resolution) that the 6080A/AN has been in operation since it was manufactured.
	Parameter:	None
	Responses:	1. (Float) Total number of hours the instrument has been operating. 2. (String) HRS
	Example:	5058.7,HRS
<b>EXPLAIN?</b>	Description:	Explain a status/error code. This command returns a string which is the explanation of the status or error code furnished as the parameter. The controller will most likely obtain the code via the STATUS? or ERROR? query. Refer to Appendices C, D, and E for a list of status and error codes.
	Parameter:	The error/status code to explain.
	Response:	(String) The explanation of the code.
	Example:	EXPLAIN? 1  Returns: "Frequency out of range"
<b>EXT_PULSE</b>	Description:	Turn external pulse modulation On or Off.
	Parameter:	ON or OFF
	Restrictions:	Rejected during single sweep.

Table 5B-3. Remote Commands (cont)

<b>EXT_PULSE?</b>	Description: Retrieve the state of external pulse modulation.
	Parameter: None
	Response: (String) ON or OFF
<b>EXTAC_AM</b>	Description: Turn external AM (AC coupled) On or Off
	Parameter: ON or OFF
	Restrictions: Rejected during single sweep.
<b>EXTAC_AM?</b>	Description: Retrieve the state of external AM (AC coupled).
	Parameter: None
	Response: (String) ON or OFF
<b>EXTAC_FM</b>	Description: Turn external FM (AC/øM coupled) On or Off.
	Parameter: ON or OFF
	Restrictions: Rejected during single sweep.
<b>EXTAC_FM?</b>	Description: Retrieve the state of external FM (AC/øM coupled).
	Parameter: None
	Response: (String) ON or OFF
<b>EXTDC_AM</b>	Description: Turn external AM (DC coupled) On or Off.
	Parameter: ON or OFF
	Restrictions: Rejected during single sweep.
<b>EXTDC_AM?</b>	Description: Retrieve the state of external AM (DC coupled).
	Parameter: None
	Response: (String) ON or OFF
<b>EXTDC_FM</b>	Description: Turn external DCFM/DCøM On or Off.
	Parameter: ON or OFF
	Restrictions: Rejected during single sweep.

Table 5B-3. Remote Commands (cont)

<b>EXTDC_FM?</b>	
Description:	Retrieve the state of external DCFM/DCøM.
Parameter:	None
Response:	(String) ON or OFF
<b>EXTREF_FREQ</b>	
Description:	Select the external reference frequency.
Parameter:	STD (10 MHz) ALT (Refer to Section 4A, "RF Frequency")
Restrictions:	Rejected during sweep.
<b>EXTREF_FREQ?</b>	
Description:	Retrieve the selected external reference frequency.
Parameter:	None
Response:	(String) STD or ALT
<b>FM</b>	
Description:	Program the FM/øM deviation in Hz or radians. The default units are HZ.
Parameter:	FM/øM deviation with optional frequency or radians units.
Restrictions:	Rejected during manual or single sweep.
<b>FM?</b>	
Description:	Retrieve the FM/øM deviation.
Parameter:	None
Responses:	1. (Float) FM/øM deviation. 2. (String) HZ or RAD
<b>FM_BRT</b>	
Description:	Move the bright digit to the specified decade in FM/øM field. Note that the unit must match the displayed units (e.g. HZ, KHZ, MHZ, or GHZ for Hz; RAD for Radians) when specifying the bright-digit position. The default units are HZ.
Parameter:	Bright-digit decade in FM/øM display field with optional frequency or radians units.
Example:	FM_BRT 10.0 KHZ
Restrictions:	Rejected during manual or single sweep.
<b>FM_BRT?</b>	
Description:	Retrieve the decade of FM/øM bright-digit position.
Parameter:	None
Responses:	1. (Float) Bright-digit decade in FM/øM display. 2. (String) HZ or RAD

Table 5B-3. Remote Commands (cont)

**FM\_RANGE**

Description: Select normal mode or low distortion or fixed range FM.  
 Parameter: NORMAL or LOWDISTORT or FIXED  
 Restrictions: Rejected during sweep.

**FM\_RANGE?**

Description: Retrieve the state of low distortion or fixed range FM.  
 Parameter: None  
 Response: (String) NORMAL or LOWDISTORT or FIXED

**FM\_STEP**

Description: Program the FM/ØM deviation step size in Hz or radians. The default units are HZ.  
 Parameter: FM/ØM deviation step size with optional frequency or radians units.  
 Example: FM\_STEP 13.26 KHZ  
 Restrictions: Rejected during manual or single sweep.

**FM\_STEP?**

Description: Retrieve the FM/ØM deviation step size.  
 Parameter: None  
 Responses: 1. (Float) FM deviation step size.  
 2. (String) HZ or RAD

**FM\_UNITS**

Description: Convert the FM/ØM display to specified units.  
 Parameter: HZ or RAD  
 Restrictions: Rejected during manual or single sweep.

**FREQ**

Description: Program the displayed RF frequency in Hz. The default units are HZ. If FREQ\_REL is OFF, this is the RF output frequency. Refer to Section 4A, "RF Frequency" for more details. If Auto Frequency Sweep is active, programs the center Frequency. Refer to Section 4E, "Sweep" for more information.  
 Parameter: Frequency with frequency units.  
 Example: FREQ 183.277281 MHZ  
 Restrictions: Rejected during manual or single sweep.

Table 5B-3. Remote Commands (cont)

**FREQ?**

Description: Retrieve the displayed RF frequency. If FREQ\_REL is OFF, this is the RF output frequency. If Frequency Sweep is active, returns the center Frequency. Refer to Section 4E, "Sweep" for more information.

Parameter: None

Responses: 1. (Float) Displayed RF frequency.  
2. (String) HZ

Example: 1.832772810E+08,HZ

**FREQ\_ABS?**

Description: Retrieve the RF output frequency.

Parameter: None

Responses: 1. (Float) Output RF frequency.  
2. (String) HZ

**FREQ\_BASE?**

Description: Retrieve the base frequency. If FREQ\_REL is OFF, this value is 0. Refer to Section 4A, "RF Frequency" for more details.

Parameter: None

Responses: 1. (Float) Base RF frequency.  
2. (String) HZ

**FREQ\_BRT**

Description: Move the bright digit to specified decade in frequency field. The default units are HZ.

Parameter: Bright-digit decade in FREQUENCY display field with optional frequency units.

Example: FREQ\_BRT 10.0 KHZ

Restrictions: Rejected during manual or single sweep.

**FREQ\_BRT?**

Description: Retrieve the decade of frequency bright-digit position.

Parameter: None

Responses: 1. (Float) Bright-digit decade in FREQUENCY display.  
2. (String) HZ

**FREQ\_MANUAL**

Description: Increment or decrement the active manual frequency sweep by specified number of counts. Note that the sign of sweep width affects the outcome of this operation.

Parameter: Number of counts to increment or decrement the active manual frequency sweep.

Restrictions: Only allowed during manual frequency sweep.

Table 5B-3. Remote Commands (cont)

<b>FREQ_REL</b>	
Description:	Select relative frequency mode. Refer to Section 4A, "RF Frequency" for more details.
Parameter:	ON or OFF
Restrictions:	Rejected during sweep.
<b>FREQ_REL?</b>	
Description:	Retrieve the state of relative frequency mode.
Parameter:	None
Response:	(String) ON or OFF
<b>FREQ_SINCR</b>	
Description:	Program the frequency sweep increment in Hz. The default units are HZ.
Parameter:	Sweep increment with optional frequency units.
Example:	FREQ_SINCR 123.322 KHZ
Restrictions:	Rejected during manual or single sweep.
<b>FREQ_SINCR?</b>	
Description:	Retrieve the frequency sweep increment.
Parameter:	None
Responses:	1. (Float) Frequency sweep increment. 2. (String) HZ
Example:	1.233220000E+05,HZ
<b>FREQ_STEP</b>	
Description:	Program the frequency step size in Hz. The default units are HZ.
Parameter:	Frequency step size with optional frequency units.
Restrictions:	Rejected during manual or single sweep.
<b>FREQ_STEP?</b>	
Description:	Retrieve the frequency step size.
Parameter:	None
Responses:	1. (Float) Frequency step size. 2. (String) HZ
Example:	3.002300000E+08,HZ

Table 5B-3. Remote Commands (cont)

<b>FREQ_SWIDTH</b>	
Description:	Program the frequency sweep width in Hz. The default units are HZ. Note that a negative value will cause a sweep from a higher frequency to a lower frequency.
Parameter:	Sweep width with optional frequency units.
Example:	FREQ_SWIDTH -9.634 KHZ
Restrictions:	Rejected during manual or single sweep.
<b>FREQ_SWIDTH?</b>	
Description:	Retrieve the frequency sweep width.
Parameter:	None
Responses:	1. (Float) Frequency sweep width. 2. (String) HZ
Example:	-9.634000000E+03,HZ
<b>GAL</b>	
Description:	Go to alternate language (the specified language is "remembered" when the power is turned off). See Section 5D, "Compatibility Languages".
Parameter:	L6080 or L6070 or L6060
<b>HIRATEPM</b>	
Description:	Turn high rate $\emptyset$ M mode On or Off.
Parameter:	ON or OFF
Restrictions:	Rejected during sweep.
<b>HIRATEPM?</b>	
Description:	Retrieve the state of the high rate $\emptyset$ M mode.
Parameter:	None
Response:	(String) ON or OFF
<b>*IDN?</b>	
Description:	Retrieve instrument identification.
Parameter:	None
Responses:	1. (String) FLUKE 2. (String) Model 3. (String) Serial Number 4. (String) Firmware Level
Example:	FLUKE,6080A/AN,12345678,V1.0
<b>INT_AM</b>	
Description:	Turn internal AM On or Off.
Parameter:	ON or OFF
Restrictions:	Rejected during single sweep.



Table 5B-3. Remote Commands (cont)

<b>INT_AM?</b>	
Description:	Retrieve the state of internal AM.
Parameter:	None
Response:	(String) ON or OFF
<b>INT_FM</b>	
Description:	Turn internal FM/øM On or Off.
Parameter:	ON or OFF
Restrictions:	Rejected during single sweep.
<b>INT_FM?</b>	
Description:	Retrieve the state of internal FM/øM.
Parameter:	None
Response:	(String) ON or OFF
<b>INT_PULSE</b>	
Description:	Turn internal pulse modulation On or Off.
Parameter:	ON or OFF
Restrictions:	Rejected during single sweep.
<b>INT_PULSE?</b>	
Description:	Retrieve the state of internal pulse modulation.
Parameter:	None
Response:	(String) ON or OFF
<b>ISCE</b>	
Description:	Loads a byte into the Instrument Status Change Enable register described under the "Checking the Instrument Status".
Parameter:	The decimal equivalent of the binary number to load into the register.
Example:	ISCE 56  Enables bits 3 (RPP), 4 (FM LO), and 5 (FM HI) in the Service Request Enable register.
<b>ISCE?</b>	
Description:	Retrieves the byte from the Instrument Status Change Enable register, described under "Checking the Instrument Status".
Parameter:	None
Response:	The decimal equivalent of the register contents byte.
Example:	ISCE?  Returns: "4" if bit 3 (RPP) is enabled (1) and the rest of the bits are disabled (0). (See "Checking the Instrument Status" for details.)

Table 5B-3. Remote Commands (cont)

**ISCR?**

Description: Retrieves and clears the byte from the Instrument Status Change Register, described under "Checking the Instrument Status".

Parameter: None

Response: The decimal equivalent of the register contents byte.

Example: ISCR?

Returns: "8" if bit 3 (RPP) is set (1) and the rest of the bits are reset (0). (See "Checking the Instrument Status" for details.)

**ISR?**

Description: Retrieves and clears the byte from the Instrument Status Register, described under "Checking the Instrument Status".

Parameter: None

Response: The decimal equivalent of the register contents byte.

Example: ISR?

Returns: "16" if bit 4 (FM LO) is set (1) and the rest of the bits are reset (0). (See "Checking the Instrument Status" for details.)

**KEY\_RATE**

Description: Select the repeat rate for the step keys.

Parameter: SLOW or MEDIUM or FAST

Restrictions: Rejected during sweep.

**KEY\_RATE?**

Description: Retrieve the key repeat rate.

Parameter: None

Response: (String) SLOW or MEDIUM or FAST

**KNOB\_STEP**

Description: Select the operation of the knob and step up/down keys. The knob can be turned on (default) or off, the step up/down keys can be configured to perform step up/down function (default) or edit up/down function.

Parameters: 1. ON or OFF (Turns the knob on or off)  
 2. STEP or EDIT (Configures the step keys)

Example: KNOB\_STEP OFF, EDIT (Knob off, step keys do edits)

Restrictions: Rejected during sweep.

Table 5B-3. Remote Commands (cont)

**KNOB\_STEP?**

Description: Retrieve the state of the knob and step up/down keys.  
 Parameter: None  
 Responses: 1. (String) ON or OFF  
 2. (String) STEP or EDIT  
 Example: OFF,EDIT (Knob off, step keys do edits)

**LOCALERT**

Description: Set mode to generate an SRQ on complete front panel operations.  
 Parameter: ON or OFF

**LOCALERT?**

Description: Retrieve the state of the local alert (LOCALERT) mode.  
 Parameter: None  
 Response: (String) ON or OFF

**LORATEFM**

Description: Turn low rate FM mode On or Off.  
 Parameter: ON or OFF  
 Restrictions: Rejected during sweep.

**LORATEFM?**

Description: Retrieve the state of the low rate FM mode.  
 Parameter: None  
 Response: (String) ON or OFF

**MEM\_DIVIDER**

Description: Program memory divider locations for sequence operations.  
 Parameter: 1. Memory divider 1 location number  
 2. Memory divider 2 location number  
 3. Memory divider 3 location number  
 4. Memory divider 4 location number  
 Example: MEM\_DIVIDER 5, 23, 45, 30  
 Restrictions: Rejected during sweep.

**MEM\_DIVIDER?**

Description: Retrieve memory divider locations for sequence operations.  
 Parameter: None  
 Responses: 1. (Integer) Memory divider 1 location number  
 2. (Integer) Memory divider 2 location number  
 3. (Integer) Memory divider 3 location number  
 4. (Integer) Memory divider 4 location number  
 Example: 5,23,30,45

Table 5B-3. Remote Commands (cont)

<b>MEM_LOCK</b>	
Description:	Set lock protection for memory store.
Parameter:	ON or OFF
Restrictions:	Rejected during sweep.
<b>MEM_LOCK?</b>	
Description:	Retrieve the state of memory lock protection.
Parameter:	None
Response:	(String) ON or OFF
<b>MEM_RESET</b>	
Description:	Reset all memory locations to the default instrument state (memory location 98).
Parameter:	None
Restrictions:	Rejected during sweep.
<b>MOD_DISPLAY</b>	
Description:	Select the quantity to be shown in the modulation field of the display. This command does not move the bright digit.
Parameter:	AM or FM or MODF or MODL
Restrictions:	Rejected during manual or single sweep.
<b>MOD_DISPLAY?</b>	
Description:	Retrieve the quantity shown in the modulation field Note that a value will be returned even though the display may be turned off with the DISPLAY command.
Parameter:	None
Response:	(String) AM or FM or MODF or MODL
<b>MOD_WAVE</b>	
Description:	Select the output waveform for the modulation oscillator.
Parameter:	SINE or TRIANGLE or SQUARE or PULSE
Restrictions:	Rejected during sweep.
<b>MOD_WAVE?</b>	
Description:	Retrieve the modulation oscillator waveform.
Parameter:	None
Response:	(String) SINE or TRIANGLE or SQUARE or PULSE

Table 5B-3. Remote Commands (cont)

<b>MODF</b>	
Description:	Program the modulation frequency in Hz. The modulation frequency may be programmed with 0.1 Hz resolution. The default units are HZ.
Parameter:	Modulation frequency with optional frequency units.
Example:	MODF 100.0001 KHZ
Restrictions:	Rejected during manual or single sweep.
<b>MODF?</b>	
Description:	Retrieve the modulation frequency.
Parameter:	None
Responses:	1. (Float) Modulation frequency. 2. (String) HZ
Example:	1.000001000E+05,HZ
<b>MODF_BRT</b>	
Description:	Move the bright digit to specified decade in modulation frequency field. The default units are HZ.
Parameter:	Bright-digit decade in modulation frequency display field with optional frequency units.
Example:	MODF_BRT 1.0 KHZ
Restrictions:	Rejected during manual or single sweep.
<b>MODF_BRT?</b>	
Description:	Retrieve the decade of modulation frequency bright-digit position.
Parameter:	None
Responses:	1. (Float) Bright-digit decade in modulation frequency display. 2. (String) HZ
<b>MODF_STEP</b>	
Description:	Program the modulation frequency step size in Hz. The default units are HZ.
Parameter:	Modulation frequency step size with optional frequency units.
Restrictions:	Rejected during manual or single sweep.
<b>MODF_STEP?</b>	
Description:	Retrieve the modulation frequency step size.
Parameter:	None
Responses:	1. (Float) Modulation frequency step size. 2. (String) HZ

Table 5B-3. Remote Commands (cont)

<b>MODL</b>	Description:	Program the modulation level in volts. The default units are V.
	Parameter:	Modulation level with optional voltage units.
	Examples:	MODL 1 MODL 100 MV
	Restrictions:	Rejected during manual or single sweep.
<b>MODL?</b>	Description:	Retrieve the modulation level.
	Parameter:	None
	Responses:	1. (Float) Modulation level. 2. (String) V
	Example:	1.000E-01,V
<b>MODL_BRT</b>	Description:	Move the bright digit to specified decade in modulation level field. The default units are V.
	Parameter:	Bright-digit decade in modulation level display field with optional voltage units.
	Example:	MODL_BRT 1.0 V
	Restrictions:	Rejected during manual or single sweep.
<b>MODL_BRT?</b>	Description:	Retrieve the decade of modulation level bright-digit position.
	Parameter:	None
	Responses:	1. (Float) Bright-digit decade in modulation level display. 2. (String) V
<b>MODL_STEP</b>	Description:	Program the modulation level step size in volts. The default units are V.
	Parameter:	Modulation level step with optional voltage units.
	Restrictions:	Rejected during manual or single sweep.
<b>MODL_STEP?</b>	Description:	Retrieve the modulation level step size.
	Parameter:	None
	Responses:	1. (Float) Modulation level step size. 2. (String) V
<b>MODOUT</b>	Description:	Select the default state of the modulation output port.
	Parameter:	ON (modulation output always at output port) OFF (modulation output only at output port when internal modulation is on)
	Restrictions:	Rejected during sweep.

Table 5B-3. Remote Commands (cont)

<b>MODOUT?</b>	
Description:	Retrieve the default state of the modulation output port.
Parameter:	None
Response:	(String) ON or OFF
<b>*OPC</b>	
Description:	<p>Sets bit 0 (OPC for "Operation Complete") in the Event Status Register to 1 when all pending device operations are complete. The 6080A/AN considers an operation complete according to the following rules.</p> <ul style="list-style-type: none"> <li>• The operation is complete when the command is processed and output has settled.</li> <li>• For those commands that do not change the output, the operation is complete when the command is processed.</li> <li>• Single sweep is complete when the sweep is complete. The operation is not complete when sweep is turned off before the sweep completes.</li> <li>• Auto and manual sweep command are complete when the starting frequency/amplitude has been programmed and the output has settled.</li> <li>• Automatic calibration/compensation procedures are complete when the procedure is complete. The operation is not complete when the procedure is aborted.</li> <li>• Other calibration/compensation procedures are complete when the first step has been programmed and the output has settled.</li> </ul>
Parameter:	None
<b>*OPC?</b>	
Description:	Returns a 1 after all pending operations are complete. This commands causes program execution to pause until all operations are complete. (See also *WAI.)
Parameter:	None
Response:	(Integer) "1" after all operations are complete.
<b>*OPT?</b>	
Description:	Retrieve report of installed options.
Parameter:	None
Responses:	(Series of strings) A comma-separated list of the option names. Each option name includes the option number and a description. If the option is not installed, a zero is returned instead of the string.
Examples:	-130 High Stability Reference,-830 Rear Output 0,-830 Rear Output
<b>PRESET</b>	
Description:	Reset instrument to preset state. See Appendix A, "Instrument Preset State".
Parameter:	None

Table 5B-3. Remote Commands (cont)

<b>*PUD</b>	
Description:	Define protected user data data. This command allows you to store a string of bytes in non-volatile memory. This command works only when the CAL COMP switch is in the 1 (on) position.
Parameter:	#0 <user data> <ASCII Line Feed with EOI> or #<non-zero digit> <digits> <user data>
	For both forms, the bytes received in the <user data> field are stored in nonvolatile memory and up to 63 bytes are allowed. The first form accepts data bytes after the #0 until the ASCII Line Feed character is received with an EOI signal.
	In the second form, the non-zero digit specifies the number of characters that will follow in the <digits> field. These characters must be 0 through 9 (ASCII 48 through 57 decimal). The value of the number in the <digits> field defines the number of user data bytes that will follow in the <user data> field.
Examples:	Store the word "FLUKE" in the protected user data area: *PUD #0FLUKE<Line Feed with EOI> or *PUD #15FLUKE
	<b>NOTE</b>
	The 1 indicates that there is one digit to follow (in this case, "5"), and the 5 indicates that there are five characters in the remainder of the *PUD message (in this case, "FLUKE").
<b>*PUD?</b>	
Description:	Retrieve protected user data buffer.
Parameter:	None
Response:	#(non-zero digit) (digits) (user data)
	The non-zero digit specifies the number of characters that will follow in the <digits> field. These characters are 0 through 9 (ASCII 48 through 57 decimal). The value of the number in the <digits> field defines the number of user data bytes that follow in the <user data> field. The maximum response is 64 characters.
Example:	*PUD? Returns: "205FLUKE" assuming that this is stored as in the example for PUD* above.
<b>PULSE_WIDTH</b>	
Description:	Program the modulation oscillator pulse width for the variable width pulse waveform in seconds. Default units are S.
Parameter:	Pulse width with optional seconds units.
Example:	PULSE_WIDTH 40.0 US
Restrictions:	Rejected during sweep.



Table 5B-3. Remote Commands (cont)

<b>PULSE_WIDTH?</b>	
Description:	Retrieve the modulation oscillator pulse width.
Parameter:	None
Responses:	1. (Float) Pulse width. 2. (String) S
Example:	4.000000000E-05,S
<b>*RCL</b>	
Description:	Recall a memory location. This command allows the user to recover the programmed instrument state from the specified memory location (contents of which are loaded by the *SAV command).
Parameter:	Memory location.
Restrictions:	Rejected during sweep.
<b>REF?</b>	
Description:	Retrieve the state of the frequency reference selection.
Parameter:	None
Response:	(String) INT or EXT
<b>RFOUT</b>	
Description:	Turns the RF output port On or Off.
Parameter:	ON or OFF
<b>RFOUT?</b>	
Description:	Retrieve the state of the RF output port.
Parameter:	None
Response:	(String) ON or OFF
<b>*RST</b>	
Description:	Reset instrument to default memory location. The default memory location is 97 (See Appendix A, "Instrument Preset State").  In addition to the recall of location 97, sweep is turned off, and any current calibration or compensation procedures are aborted. No other actions are performed on the *RST command.
Parameter:	None
<b>*SAV</b>	
Description:	Save (store) to a memory location. This command allows a user to store the current instrument programmed state in a specified memory location for later retrieval by the *RCL command.
Parameter:	Memory location.
Restrictions:	Rejected during sweep.

Table 5B-3. Remote Commands (cont)

<b>SD</b>	Description:	Step the active step field down by one step size.
	Parameter:	None
	Restrictions:	Rejected during single sweep.
<b>SEQ</b>	Description:	Recall the next or previous memory location.
	Parameter:	UP or DOWN
	Restrictions:	Rejected during sweep.
<b>SPCL</b>	Description:	Select a special function by number.
	Parameter:	Special function number.
<b>*SRE</b>	Description:	Program the Service Request Enable register (SRE), described under "Checking the Instrument Status".
	Parameter:	The decimal equivalent of the binary number to load into the register.
	Example:	*SRE 56  Enables bits 3 (IIR), 4 (MAV), and 5 (ESR) in the Service Request Enable register.
<b>*SRE?</b>	Description:	Retrieve Service Request Enable register, described in under the heading "Checking the Instrument Status".
	Parameter:	None
	Response:	(Integer) The decimal equivalent of the register byte.
	Example:	*SRE?  Returns: "56" if bits 3 (IIR), 4 (MAV), and 5 (ESR) are enabled (1) and the rest of the bits are disabled (0). (See "Checking the Instrument Status" for details.)
<b>STATUS</b>	Description:	Load specified status into the status queue. Uncal, self-test, memory checksum, and memory origin status can be loaded.
	Parameter:	UNCAL or SELFTEST or CHECKSUM or ORIGIN

Table 5B-3. Remote Commands (cont)

<b>STATUS?</b>	
Description:	Retrieve a status code from the status queue. If no status codes have been loaded with the STATUS command or if all the enqueued status codes have been retrieved, a zero is returned. If the optional keyword EXPLAIN is specified, a character string containing its explanation is returned with the status code.
Parameter:	(optional) EXPLAIN
Examples:	STATUS? Returns: 220 (If the RPP has tripped)
	STATUS? EXPLAIN Returns: 220, "RPP tripped" (If the RPP has tripped)
Responses:	1. (Integer) Currently loaded uncal, self-test, or memory status code, or a zero. 2. (optional) (String) The explanation of the code.
<b>*STB?</b>	
Description:	Retrieve the status byte. The status byte is described in under the heading "Checking the Instrument Status".
Parameter:	None
Response:	(Integer) Decimal equivalent of the status byte.
Example:	*STB?  Returns: "72" if bits 3 (EAV) and 6 (MSS) are set (1) and the rest of the bits are reset (0).
<b>STEP_AM</b>	
Description:	Step the AM depth up or down by one step size.
Parameter:	UP or DOWN
Restrictions:	Rejected during single sweep.
<b>STEP_AMPL</b>	
Description:	Step the output amplitude up or down by one step size.
Parameter:	UP or DOWN
Restrictions:	Rejected during single sweep.
<b>STEP_FIELD</b>	
Description:	Program the specified field to be used for the step up/down functions.
Parameter:	AM or AMPL or FM or FREQ or MODF or MODL
Restrictions:	Rejected during single sweep.
<b>STEP_FIELD?</b>	
Description:	Retrieve the current step field.
Parameter:	None
Response:	(String) AM or AMPL or FM or FREQ or MODF or MODL

Table 5B-3. Remote Commands (cont)

<b>STEP_FM</b>	Description:	Step the FM/øM deviation up or down by one step size.
	Parameter:	UP or DOWN
	Restrictions:	Rejected during single sweep.
<b>STEP_FREQ</b>	Description:	Step the output frequency up or down by one step size.
	Parameter:	UP or DOWN
	Restrictions:	Rejected during single sweep.
<b>STEP_MODF</b>	Description:	Step the modulation frequency up or down by one step size.
	Parameter:	UP or DOWN
	Restrictions:	Rejected during single sweep.
<b>STEP_MODL</b>	Description:	Step the modulation level up or down by one step size.
	Parameter:	UP or DOWN
	Restrictions:	Rejected during single sweep.
<b>SU</b>	Description:	Step the active step field up by one step size.
	Parameter:	None
	Restrictions:	Rejected during single sweep.
<b>SWEEP</b>	Description:	Select the sweep mode.
	Parameter:	OFF or AUTO or MANUAL or SINGLE
<b>SWEEP?</b>	Description:	Retrieve the sweep mode.
	Parameter:	None
	Response:	(String) OFF or AUTO or MANUAL or SINGLE
<b>SWEEP_DWELL</b>	Description:	Program the sweep dwell time. Default units are S.
	Parameter:	Dwell time with optional seconds units.
	Example:	SWEEP_DWELL 500 MS

Table 5B-3. Remote Commands (cont)

<b>SWEEP_DWELL?</b>	
Description:	Retrieve the sweep dwell time.
Parameter:	None
Responses:	1. (Integer) Dwell time. 2. (String) S
<b>SWEEP_FIELD</b>	
Description:	Select the sweep field.
Parameter:	FREQ (Frequency) AMPL (Amplitude)
Restrictions:	Rejected during sweep.
<b>SWEEP_FIELD?</b>	
Description:	Retrieve the sweep field.
Parameter:	None
Response:	(String) FREQ or AMPL
<b>SWEEP_SYM</b>	
Description:	Select the sweep symmetry.
Parameter:	ASYM (Asymmetrical) SYMM (Symmetrical)
Restrictions:	Rejected during single sweep.
<b>SWEEP_SYM?</b>	
Description:	Retrieve the sweep symmetry.
Parameter:	None
Response:	(String) ASYM or SYMM
<b>TEST_ATT</b>	
Description:	Program alternate attenuator settings.
Parameter:	A24B or A24C or A24D or A24E
Restrictions:	Rejected during sweep.
<b>TEST_DISP</b>	
Description:	Execute display test.
Parameter:	ON or OFF
Restrictions:	Rejected during sweep.
<b>*TRG</b>	
Description:	Trigger device. Cause the commands defined with the *DDT common command to be executed. If the *DDT has been specified with a zero-length data block, no action will be taken.
Parameter:	None

Table 5B-3. Remote Commands (cont)

**\*TST?**

Description: Initiates a series of self-tests, then returns a "0" for pass or a "1" for fail. If any tests fail, they can be loaded into the status queue with the STATUS SELF-TEST command. The enqueued status codes can be queried with the STATUS? command. Refer to the Service Manual for a description of tests performed.

Parameter: None

Response: (Integer) 0 (for Pass) or 1 (for Fail)

Restrictions: Turns sweep or calibration or compensation procedure off.

**\*WAI**

Description: Wait until all pending remote operations are complete. This command prevents further remote commands from being executed until all previous remote commands have been completely executed.

Parameter: None

## Section 5C

# Talk-Only/Listen-Only Operation

### INTRODUCTION

5C-1.

The 6080A/AN can be used with any IEEE-488 controller in the normal addressed mode. The listen-only and talk-only modes are available for operation without a controller.

In the listen-only mode, the 6080A/AN responds to all data messages on the IEEE-488 bus. In the talk-only mode, the 6080A/AN sends commands on the IEEE-488 bus to program another 6080A/AN.

### TALK-ONLY OPERATION

5C-2.

In talk-only, the 6080A/AN outputs the step up (“;SU”) and step down (“;SD”) commands whenever the front panel step up and down entries are made.

Two 6080A/ANs can be set up to track in frequency with an offset by connecting one 6080A/AN in talk-only to another 6080A/AN in listen-only. This is done by: programming the two signal generators to the desired frequencies; programming the frequency step value to be the same on both generators; and pressing the step up or step down keys on the generator that is in talk-only mode. Note that if the step sizes are different or if the functions selected to step are different, the signal generators will no longer track with the same offset.

Any of the six functions may be stepped (frequency, amplitude, AM depth, FM deviation, modulation frequency, and modulation level), and the step function of the talker need not match that of the listener.

A Fluke 6060A, 6060B, 6061A, or 6062A may also be used as the listener with the limitation that they cannot step modulation frequency or modulation level. A Fluke 6070A or 6071A may be used as the listener with the limitation that it will always step frequency.

The 6080A/AN implements the talk-only (ton) function described in the IEEE-488.1 standard. The IEEE-488.2 standard does not cover talk-only operation.

The talk-only mode is selected by the talker/listener special function described in Section 5, “Remote Operation”. When the mode is changed, the IEEE-488 interface chip is reset, and any current IEEE-488 bus activity is discarded. In talk-only, the signal generator is always in local, and is always addressed as a talker. The ADDR annunciator is always be lit.

In talk-only, the device clear, trigger, and serial poll messages are ignored.

## LISTEN-ONLY OPERATION

5C-3.

A Fluke 6060A, 6060B, 6061A, or 6062A may be used as a talk-only instrument with a 6080A/AN as the listener. They output “,SU” and “,SD” which will cause a command error for the 6080 language. Therefore, if the 6080A/AN is to be the listener, it should be configured to one of the compatibility languages as described in Section 5, “Remote Operation”.

The 6080A/AN implements the listen-only (lon) function described in the IEEE-488.1 standard. The IEEE-488.2 standard does not cover listen-only operation.

The listen-only mode is selected by the talker/listener special function described in Section 5, “Remote Operation”. When the mode is changed, the IEEE-488 interface chip is reset, and any current IEEE-488 bus activity is discarded. In listen-only, the signal generator is always in local, and is always addressed as a listener. The ADDR annunciator is always lit.

In listen-only, the 6080A/AN will respond to all commands that are allowed with the exception of queries and calibration/compensation commands. These commands will be processed with no errors, but nothing will be sent over the bus.

In listen-only, device clear, trigger, and serial poll messages will be ignored.

## LISTEN-ONLY/TALK-ONLY EXAMPLE

5C-4.

The 6080A/AN can be connected to another 6080A/AN in a master-slave configuration. In the following example, two 6080A/ANs are configured to track each other in frequency. This configuration may be used to track frequency, amplitude, AM, FM, Modulation Frequency or Modulation Level.



1. Connect two 6080A/ANs together with an IEEE-488 cable.
2. Set the talker/listener mode of the first 6080A/AN (talker) to talk-only by entering   , then entering  in response to the prompt.
3. Set the talker/listener mode of the second 6080A/AN (listener) by entering   , then entering  in response to the prompt.
4. Manually program the talker 6080A/AN as follows:

FUNCTION	VALUE	KEY SEQUENCE
Frequency	210 MHz	<input type="text" value="FREQ"/> <input type="text" value="2"/> <input type="text" value="1"/> <input type="text" value="0"/> <input type="text" value="MHz V"/>
Step Function	Frequency	<input type="text" value="FREQ"/> <input type="text" value="STEP"/>
Frequency Step	1.25 kHz	<input type="text" value="1"/> <input type="text" value="—"/> <input type="text" value="2"/> <input type="text" value="5"/> <input type="text" value="kHz mV"/>

5. Manually program the listener 6080A/AN as follows:

FUNCTION	VALUE	KEY SEQUENCE
Frequency	195 MHz	<input type="text" value="FREQ"/> <input type="text" value="1"/> <input type="text" value="9"/> <input type="text" value="5"/> <input type="text" value="MHz V"/>
Step Function	Frequency	<input type="text" value="FREQ"/> <input type="text" value="STEP"/>
Frequency Step	1.25 kHz	<input type="text" value="1"/> <input type="text" value="—"/> <input type="text" value="2"/> <input type="text" value="5"/> <input type="text" value="kHz mV"/>



6. On the talker 6080A/AN, press the  STEP or  STEP keys. Each time the key is pressed, the frequency of both 6080A/ANs increases or decreases by 1.25 kHz (the Frequency Step) at frequencies 15 MHz apart.

Different functions on each 6080A/AN can be programmed to track in the master-slave configuration. In other words, while the master 6080A/AN can be programmed to step increase 25 kHz FM, the slave 6080A/AN can be programmed to step 25% AM.

*NOTE*

*To use the step feature for other functions, change the step function on the 6080A/ANs to the desired functions.*



## Section 5D

# Compatibility Languages

### INTRODUCTION

**5D-1.**

The default 6080A/AN operation complies with the IEEE-488.2 standard. It can also be configured to be compatible with the Fluke 6060A, 6060B, 6061A, 6062A, 6070A, and 6071A in functions and response to system controller software. In this mode, the 6080A/AN no longer complies with the IEEE-488.2 standard.

Two compatibility languages are provided, one for the 6060 family products and another for the 6070 family products.

### PROGRAMMING THE LANGUAGE

**5D-2.**

The language is selected from the front panel as described in Section 5, "Remote Operation".

The GAL command is used to select the language from remote. GAL without arguments will switch to the 6080 language from any language. When in the 6080, language arguments to the GAL command are L6060, L6070, and L6080. For example, to put the 6080A/AN in the 6070 language, the following programming string may be sent: "GAL; GAL L6070".

Some commands do not exist in the compatibility languages. It is possible to intersperse 6080 commands with compatibility commands by inserting appropriate GAL commands. For example, the compatibility languages do not include the queries. The command string "FR 100 HZ; GAL; FREQ?; GAL L6070" may be used to temporarily switch to the 6080 language to query the frequency.

### Incompatibilities

**5D-3.**

Most of the operations are identical to the 6060 and 6070 signal generators when using the compatibility language. A few minor differences do exist and are described in the following paragraphs.

The instrument limits and specifications are those of the 6080A/AN. For example, the frequency limits are 10 kHz to 1056 MHz for the FR command, even though the 6070A frequency limits are 200 kHz to 520 MHz.

The timing of programming and data transfer on the IEEE-488 bus will not be the same. The 6080A/AN will generally be faster than the 6060 family and slower than the 6070 family of products.

## REMOTE OPERATION COMPATIBILITY LANGUAGES

Status, rejected entry, and self-test codes are similar but not exactly the same. Those codes that are the same will be reported as they are in the 6060 or 6070 instruments. Most special functions for the 6060 and 6070 instruments are available in the 6080A/AN and the compatibility language will accept the 6060 or 6070 codes. Tables 5D-1 and 5D-2 list the codes and special functions for the 6060 and 6070 compatibility languages.

Three of the interface modes (record, unbuffered, and valid) have been replaced with the interrogate complete (IP) and wait (WA) commands. Refer to the 6080 language commands \*OPC? and \*WAI for a description of their operation.

The response to the IO command will be the code for the 6080A/AN, not the compatibility instrument. For example, the response "12,0,0" indicates that the instrument is a 6080A/AN with no options.

The bit values in the serial poll status byte are defined differently. However, two copies of the enable register and the status byte are maintained so that if only status codes available for the 6060 or 6070 are used, the SRQ line will not change when switching languages.

Some commands that are not commonly used have been eliminated in the compatibility language. Most of these are available in the 6080 language and can always be accessed by switching languages. Table 5D-3 shows the 6060 and 6070 commands supported in the compatibility languages. Some commands are listed as being available only for the 6080. These are for features such as programmable modulation level that are not available in the 6060 or 6070.

In the 6060 and 6070 instruments, numeric data can be sent in hexadecimal as well as the default decimal. This feature is not included in the 6060 and 6070 compatibility languages, but a similar capability is available in the 6080 language.

### **Converting 6060 and 6070 Programs to Use the 6080 Language** **5D-4.**

Users of 6060 and 6070 instruments may wish to convert their programs to use the new features available in the 6080 language. The following paragraphs describe the differences between the compatibility language and the 6080 language to help with the conversion.

In the 6080 language, programming mnemonics are longer and more meaningful than the two-character commands in the compatibility language. A complete list is provided in Table 5D-3. All special functions are accessed mnemonically rather than with special function codes.

Device clear and the \*RST command are defined by the IEEE-488.2 standard. The 6080 device clear is limited to clearing the input buffer and output queue and turning sweep and cal/comp procedures off. The \*RST does a recall location 98 and clears the trigger buffer. In the compatibility language, the device clear clears the input and output queue and the equivalent of a CL command. The CL command clears the output queue, turns sweep and cal/comp procedures off, clears the trigger buffer, clears errors, turns the RF output on, and initializes the serial poll register enable and memory dividers.

A programming message syntax is defined by the IEEE-488.2 standard. There must be white space between the header and the numeric. This is not the case in the compatibility language. For example, "FM100HZ" is valid in the compatibility language but "FM 100HZ" is required in the 6080 language.

In the compatibility language, string terminators are defined to be comma and semicolon and are optional between programming commands. For example, "FM100HZSUROI" is equivalent to "FM100HZ,SU;ROI". In the 6080 language, comma is defined to be a data separator and is required between data elements. The semicolon is defined to be the message unit separator and is required between programming commands. For example, "FM 100 HZ; STEP\_FM UP; RFOUT ON".

Units in the 6080 language are defined by the IEEE-488.2 standard and are not the same as the 6060 and 6070. Table 5D-4 lists the units in both languages.

The 6080 language uses parameters that are mnemonic such as ON and OFF to replace the 1 or 0 used in the compatibility language.

The IEEE-488.2 common command, \*IDN? returns manufacturer, model, serial number, and software version number. This one command replaces the compatibility commands ID, IS, and IV.

A status response in the compatibility language was defined to include the terminator character. For example if the serial poll register enable (SRQ mask) is 134, the command "IM;IM"<terminator> will return "134"<terminator>"134"<terminator>. In the 6080 language, multiple queries within one program message are separated by semicolons, and a terminator is sent at the end. For example, "\*SRE?;\*SRE?"<terminator> will return "134;134"<terminator>. In the compatibility language, the terminator is programmable, but in the 6080 language it is always linefeed with EOI asserted.

In the 6080 language, new programming commands cause previous query responses to be flushed from the output queue. In the compatibility language, the output queue is not flushed on new programming commands. For example, "\*SRE?"<terminator> "\*SRE100"<terminator> clears the \*SRE? response, but "IM"<terminator> "SM100"<terminator> does not clear the IM response.

In the 6080 language, if a query but not a terminator is received and the status data is requested to be transferred to the IEEE-488 controller, an error is generated and the output queue is flushed. No error is generated in the compatibility language.

The bit values in the serial poll status byte are different. Refer to the "Checking the Instrument Status" in Section 5A.

After a syntax error, the 6080 language will ignore all characters until a terminator is found. The compatibility language will discard errors until a terminator, comma, or semicolon is found.

The interface modes (@ modes) have been replaced with the IEEE-488.2 common commands \*OPC, \*OPC?, and \*WAI defined in the IEEE-488.2 standard. Refer to the heading "Using the \*OPC?, \*OPC, and \*WAI Commands" in Section 5A.

REMOTE OPERATION  
COMPATIBILITY LANGUAGES

Table 5D-1. 6060 Compatibility Language Codes and Special Functions

RETURNED IN 6060 MODE	EQUIVALENT 6080 STATUS	DESCRIPTION
<b>Status (value returned on 6060 IU command)</b>		
000001,000000,000000	222	FM DAC at 0
000002,000000,000000	224	FM out of range for RF frequency band
000004,000000,000000	*	Excess FM Deviation
000010,000000,000000	223	FM DAC at full scale
000020,000000,000000	*	AM depth too high
000200,000000,000000	250	Multiple compensation memory errors
000000,000010,000000	246	Reference unlocked
000000,000000,000001	*	Level DAC below calibrated range
000000,000000,000002	*	Peak (AM) amplitude too high
000000,000000,000004	241	ALC loop unleveled
000000,000000,000010	220	Level DAC at 0
000000,000000,000020	221	Level DAC at full scale
000000,000000,000040	240	RPP tripped
000000,000000,000100	*	Amplitude too low
000000,000000,000200	201	Level correction disabled
000000,000000,000400	*	RF output off
001000,000000,000000	**	All other codes new for 6080A/AN
<b>Rejected entry (value returned on "IR" command)</b>		
000001,000000,000000	30	FM/ØM deviation out of range
000002,000000,000000	31	FM/ØM step size out of range
000004,000000,000000	20	AM depth out of range
000010,000000,000000	21	AM step size out of range
000020,000000,000000	73	IEEE bad command syntax
000040,000000,000000	74	IEEE bad argument value
000100,000000,000000	98	MEC PROM ID code invalid, or MEC PROM checksum error
000200,000000,000000	71	IEEE invalid edit or step
000400,000000,000000	97	Stored cal/comp data has invalid data point
000000,000001,000000	1	Frequency out of range
000000,000002,000000	90,95	CALCOMP switch not set to 1 (on)
000000,000004,000000	2	Frequency step size out of range
000000,000010,000000	92	Cal/comp procedure incomplete, data cannot be stored
000000,000020,000000	94	Invalid cal/comp command
000000,000040,000000	61	Invalid memory location
000000,000100,000000	62	Memory location data invalid
000000,000200,000000	60	Invalid special function code
000000,000400,000000	93	Cal/comp data range error (too much correction)
000000,000000,000001	10	Amplitude out of range
000000,000000,000002	11	Amplitude unit conversion out of range
000000,000000,000004	12	Units conversion not allowed with voltage reference
000000,000000,000020	13	Amplitude step size out of range
000000,000000,000040	15	Amplitude step units conversion not allowed
000000,000000,000100	14	Amplitude step with mixed units not allowed
000000,000000,000200	91	Cal/comp out of range adjustment
000000,000000,000400	96	Internal cal/comp data transfer error
001000,000000,000000	**	All other rejected entry codes new for 6080A/AN

Table 5D-1. 6060 Compatibility Language Codes and Special Functions (cont)

RETURNED IN 6060 MODE	EQUIVALENT 6080 STATUS	DESCRIPTION
<b>Self-test (value returned on 6060 IT command)</b>		
000,000,000,000 777,777,777,777		All tests passed Some tests failed. Go to the 6080 language to query the results.
000,-000,000,000 777,-777,777,777		Tests were aborted. Some tests failed and tests were aborted.
SENT IN 6060 MODE	EQUIVALENT 6080 CODE	DESCRIPTION
<b>Special function (value sent with 6060 SP command)</b>		
00	00	Clears all special functions
02	02	Initiates power-on self-tests
03	*	Display test.
04	*	Button test.
07	14	Set front panel SRQ
08	15	Clear front panel SRQ
09	*	Display software revision level
10	*	Display IEEE-488 address and talker/listener mode
11	*	Display self-test results
12,13	770,771	Disable display
14	*	Initialize memory locations
15	*	Latch test.
16	*	Display option loading status
17	*	Initiate self-tests with RF output enabled
20,21	20,21	Relative frequency
30,31	30,31	Relative amplitude.
40,41	740,741	Internal pulse modulation
50-52	840-842	Select amplitude display units
60,61	****	DCAM
70-72	860-862	Select repeat rate for step keys
75	*	Display cal/comp memory checksum status and data origins
76	*	Repair cal/comp memory checksum errors
77-79	*	Transfer MEC Prom Data
80-82	920-922	Apply amplitude compensation
83-86	923-926	Program alternate 24 dB attenuators
90,91	50,51	Amplitude fixed range
95-98	*	Manual compensation procedures
<b>NOTES:</b> * Feature not available for the 6080A/AN, rejected for special functions. ** Feature new for the 6080A/AN, no equivalent code for the 6060. *** Special function rejected, it is only available from the front panel. **** Special function rejected, use "DA1" instead of "SP61, AE1" and "DA0" instead of "SP61, AE0".		

REMOTE OPERATION  
COMPATIBILITY LANGUAGES

Table 5D-2. 6070 Compatibility Language Codes and Special Functions

RETURNED IN 6070 MODE	EQUIVALENT 6080 STATUS	DESCRIPTION
<b>Status (value returned on 6070 IU command)</b>		
000001,000000,000000,000000	222	FM DAC at 0
000002,000000,000000,000000	224	FM out of range for RF frequency band
000004,000000,000000,000000	247	FM loop unlocked
000010,000000,000000,000000	*	ACFM deviation too high
000020,000000,000000,000000	223	FM DAC at full scale
000040,000000,000000,000000	*	Delay discriminator unlevelled
000100,000000,000000,000000	*	ACFM deviation too high
000200,000000,000000,000000	*	DCFM deviation too high
000000,000001,000000,000000	*	Modulation frequency DAC too low
000000,000002,000000,000000	*	Modulation frequency DAC too high
000000,000004,000000,000000	*	FM deviation too high
000000,000020,000000,000000	*	AM depth too high
000000,000000,000001,000000	*	6071A frequency out of calibrated limits
000000,000000,000002,000000	*	Mod divider filters out of calibrated limits
000000,000000,000004,000000	*	Frequency out of calibrated limits
000000,000000,000010,000000	242	Sub synthesizer unlocked
000000,000000,000020,000000	*	Delay discriminator not ready
000000,000000,000040,000000	*	Excess FM deviation
000000,000000,000100,000000	246	Reference phase detector unlocked
000000,000000,000000,000001	*	Level DAC too low
000000,000000,000000,000002	*	Peak (AM) amplitude too high
000000,000000,000000,000004	241	ALC loop unlevelled
000000,000000,000000,000010	220	Level DAC at 0
000000,000000,000000,000020	221	Level DAC at full scale
000000,000000,000000,000040	240	RPP tripped
000000,000000,000000,000100	*	Amplitude too low
000000,000000,000000,000200	201	Level correction disabled
001000,000000,000000,000000	**	All other status codes new for 6080A/AN
<b>Rejected entry (value returned on 6070 IR command)</b>		
000001,000000,000000,000000	30	FM/ØM deviation out of range
000002,000000,000000,000000	*	DCFM not allowed when phase modulation enabled
000004,000000,000000,000000	*	Radians entry not allowed with DCFM enabled
000010,000000,000000,000000	32	FM/ØM units conversion not allowed when external FM enabled
000020,000000,000000,000000	33	FM/ØM units conversion out of ØM range
000040,000000,000000,000000	61	Invalid memory location
000100,000000,000000,000000	*	Invalid memory location for insert/delete operation
000200,000000,000000,000000	62	Memory location data invalid
000000,000001,000000,000000	20	AM depth out of range
000000,000002,000000,000000	40	Mod frequency out of range
000000,000004,000000,000000	60	Invalid special function code
000000,000010,000000,000000	73	IEEE bad command syntax
000000,000020,000000,000000	74	IEEE bad argument value
000000,000040,000000,000000	71	IEEE invalid edit or step



Table 5D-2. 6070 Compatibility Language Codes and Special Functions (cont)

RETURNED IN 6070 MODE	EQUIVALENT 6080 STATUS	DESCRIPTION
000000,000100,000000,000000	*	IEEE invalid bright digit value
000000,000200,000000,000000	*	Bright-digit cannot be enabled during sweep
000000,000000,000001,000000	1	Frequency out of range
000000,000000,000004,000000	2,3,4	Frequency step size/sweep width/sweep increment out of range
000000,000000,000010,000000	52	Entry conflicts with current sweep
000000,000000,000020,000000	51	Cannot enable sweep with current parameters
000000,000000,000000,000001	10	Amplitude out of range
000000,000000,000000,000002	11	Amplitude unit conversion out of range
000000,000000,000000,000004	12	Units conversion not allowed with voltage reference
001000,000000,000000,000000	**	All other rejected entry codes new for 6080A/AN
<b>Self-test (value returned on 6070 IT command)</b>		
000000 777777		All tests passed Some tests failed. Go to the 6080 language to query the results.
-000000 -777777		Tests were aborted. Some tests failed and tests were aborted.
SENT IN 6070 MODE	EQUIVALENT 6080 CODE	DESCRIPTION
<b>Special function (value sent with 6070 SP command)</b>		
00	00	Clears all currently set stored special functions
01	***	Display special function status
02	02	Initiates the power-on self-tests
03	***	Display test.
04	***	Button test.
05	*	Pattern sensitive RAM check
06	*	Non-volatile memory check
07	14	Set SRQ
08	15	Reset SRQ
09	***	Display instrument software revision level.
10,11	****	Forced DCFM
20,21	*	Forced high deviation
30,31	50,51 & 730,732	Fixed range
40	890	Select sweep dwell time of 0 mS
41-44	891-895	Select sweep dwell time
50,51	880,881	Select sweep symmetry
60,61	*	Wideband reference
70,71	40,41	Modulation oscillator output
80,81	920,921	Apply amplitude compensation
<b>NOTES:</b> * Feature not available for the 6080A/AN, rejected for special functions. ** Feature new for the 6080A/AN, no equivalent code for the 6070. *** Special function rejected, it is only available from the front panel. **** Special function rejected, use "DF1" instead of "SP11, FE1" and "DF0" instead of "SP11, AF0".		

REMOTE OPERATION  
COMPATIBILITY LANGUAGES

Table 5D-3. Compatibility Language Commands

COMPAT. COMMAND	6080 COMMAND	DESCRIPTION	6070 & 6071	6060 & 6061	6062	6080
@	–	Set up interface modes	6070	6060	6062	
AB	AMPL_BRT	Position amplitude bright digit	6070	6060	6062	6080
AE	EXTAC_AM	Disable/enable external AM	6070	6060	6062	6080
AI	INT_AM	Disable/enable internal AM	6070	6060	6062	6080
AM	AM	Program AM depth	6070	6060	6062	6080
AN	AMPL_SINCR	Program amplitude sweep incr.				6080
AP	AMPL	Program amplitude	6070	6060	6062	6080
AS	SWEEP	Start (auto) sweep operation	6070			6080
AW	AMPL_SWIDTH	Program amplitude sweep width				6080
CB		Clear IEEE output buffer	6070	6060	6062	
CE	*CLS	Clear error status		6060	6062	6080
CL	PRESET	Device clear	6070	6060	6062	6080
CT	*DDT	Configure trigger buffer	6070	6060	6062	6080
DA	EXTDC_AM	Disable/enable external DCAM			6062	6080
DB	FM_BRT	Position FM bright digit	6070	6060	6062	6080
DD	STEP_FM	Step (down) FM		6060	6062	6080
DF	EXTDC_FM	Disable/enable external DCFM				6080
DQ	SEQ	Sequence (down) to next mem loc				6080
DS	FM_STEP	Program FM step		6060	6062	6080
DU	STEP_FM	Step (up) FM		6060	6062	6080
DW	–	Define RAM/ROM base address	6070	6060	6062	
EM	–	Disable/enable error mode		6060	6062	
FB	FREQ_BRT	Position frequency bright digit	6070	6060	6062	6080
FD	STEP_FREQ	Step (down) frequency		6060	6062	6080
FE	EXTAC_FM	Disable/enable external FM	6070	6060	6062	6080
FI	INT_FM	Disable/enable internal FM	6070	6060	6062	6080
FM	FM	Program FM deviation	6070	6060	6062	6080
FR	FREQ	Program frequency	6070	6060	6062	6080
FS	FREQ_STEP	Program frequency step	6070	6060	6062	6080
FU	STEP_FREQ	Step (up) frequency		6060	6062	6080
GAL	GAL	Go to alternate language				6080
IA	ATT_LOG?	Query attenuator log		6060	6062	6080
IB	–	Input I/O bit	6070	6060	6062	
ID	*IDN?	Query instrument ID	6070	6060	6062	6080
IE	ETIME?	Query elapsed time		6060	6062	6080
II	–	Query interface “@” modes		6060	6062	
IL	–	Query error log		6060	6062	
IM	*SRE?	Query status register enable	6070	6060	6062	6080
IO	*OPT?	Query option loading	6070	6060	6062	6080
IP	*OPC?	Query operation complete	6070	6060	6062	6080
IR	ERROR?	Query rejected entry status	6070	6060	6062	6080
IS	*IDN?	Query instrument serial number			6062	6080
IT	STATUS?	Query self-test status	6070	6060	6062	6080

**Table 5D-3. Compatibility Language Commands (cont)**

COMPAT. COMMAND	6080 COMMAND	DESCRIPTION	6070 & 6071	6060 & 6061	6062	6080
IU	STATUS?	Query uncal status	6070	6060	6062	6080
IV	*IDN?	Query software version	6070	6060	6062	6080
KA	EDIT_AMPL	Edit amplitude	6070	6060	6062	6080
KB	-	Edit current bright digit field	6070	6060	6062	
KD	EDIT_FM	Edit FM deviation	6070	6060	6062	6080
KF	EDIT_FREQ	Edit frequency	6070	6060	6062	6080
KM	EDIT_MODF	Edit modulation frequency	6070			6080
KN	EDIT_MODL	Edit modulation level				6080
KP	EDIT_AM	Edit AM depth	6070	6060	6062	6080
LD	STEP_AMPL	Step (down) amplitude		6060	6062	6080
LS	AMPL_STEP	Program amplitude step		6060	6062	6080
LU	STEP_AMPL	Step (up) amplitude		6060	6062	6080
MB	MODF_BRT	Position mod freq bright digit	6070		6062	6080
MD	STEP_MODF	Step (down) modulation freq				6080
MF	MODF	Program modulation frequency	6070	6060	6062	6080
MI	MODF_STEP	Program modulation freq step				6080
ML	MODL	Program modulation level				6080
MR	-	Program mod freq to 400/1000 Hz		6060	6062	
MS	SWEEP	Start (manual) sweep operation	6070			6080
MU	STEP_MODF	Step (up) modulation freq				6080
NB	MODL_BRT	Position mod level bright digit				6080
ND	STEP_MODL	Step (down) modulation level				6080
NS	MODL_STEP	Program modulation level step				6080
NU	STEP_MODL	Step (up) modulation level				6080
OD	-	Output I/O DAC	6070	6060	6062	
PB	AM_BRT	Position AM bright digit	6070	6060	6062	6080
PD	STEP_AM	Step (down) AM depth		6060	6062	6080
PE	EXT_PULSE	Disable/enable external pulse			6062	6080
PI	INT_PULSE	Disable/enable internal pulse			6062	6080
PS	AM_STEP	Program AM step		6060	6062	6080
PU	STEP_AM	Step (up) AM depth		6060	6062	6080
PW	PULSE_WIDTH	Program mod osc pulse width				6080
RA	AMPL_REL	Disable/enable relative amplitude	6070	6060	6062	6080
RB	-	Query I/O byte	6070	6060	6062	
RC	*RCL	Recall memory location	6070	6060	6062	6080
RF	FREQ_REL	Disable/enable relative freq	6070	6060	6062	6080
RO	RFOUT	Turn RF output off/on	6070	6060	6062	6080
RW	-	Query I/O word	6070	6060	6062	
SD	SD	Step down	6070	6060	6062	6080
SF	SWEEP_FIELD	Select sweep field				6080
SI	FREQ_SINCR	Program freq sweep increment	6070			6080
SM	*SRE	Set service request enable	6070	6060	6062	6080

**REMOTE OPERATION  
COMPATIBILITY LANGUAGES**

**Table 5D-3. Compatibility Language Commands (cont)**

<b>COMPAT. COMMAND</b>	<b>6080 COMMAND</b>	<b>DESCRIPTION</b>	<b>6070 &amp; 6071</b>	<b>6060 &amp; 6061</b>	<b>6062</b>	<b>6080</b>
SO	SWEEP	Stop sweep operation	6070			6080
SP	SPCL	Program special functions	6070	6060	6062	6080
SQ	SEQ	Sequence (up) to next mem loc		6060	6062	6080
SS	SWEEP	Start (single) sweep operation	6070			6080
ST	*SAV	Save (store) memory location	6070	6060	6062	6080
SU	SU	Step up	6070	6060	6062	6080
SW	FREQ_SWIDTH	Program frequency sweep width	6070			6080
TM	-	Set terminator mode		6060	6062	
TR	*TRG	Trigger device	6070	6060	6062	6080
WA	*WAI	Wait until operation complete				6080
WB	-	Set I/O byte	6070	6060	6062	
WW	-	Set I/O word	6070	6060	6062	
XA		Query attenuator value	6070	6060	6062	
XB	-	Set attenuator value	6070	6060	6062	
XD	-	Program sub-synthesizer freq	6070	6060	6062	
XF	LOCALERT	Set local alert mode	6070	6060	6062	6080
XR	-	Fast RF on/off	6070	6060	6062	

Table 5D-4. Compatibility Language Units

UNIT NAME	COMPATIBILITY LANGUAGE	6080 LANGUAGE
Hertz Kilohertz Megahertz Gigahertz	HZ KZ MZ GZ	HZ KHZ MHZ or MAHZ GHZ
dBm dB dBmV dB $\mu$ V dBf	DB DB - - -	DBM or DBMW DB DBMV DBUV DBF or DBFW
Volt Millivolt Microvolt Nanovolt	V MV UV NV	V MV UV NV
Percent	PC	PCT
Radian	RD	RAD
Second	SC	S



# **Appendix A Instrument Preset State**

**INSTRUMENT PRESET STATE**

**Appendix A. Instrument Preset State**

FUNCTION	SET TO STATES		
	SPCL 00	RCL 97 <sup>1</sup>	SPCL 01 <sup>2</sup> (PRESET)
<b>FREQUENCY</b>			
Output frequency		1000 MHz	1000 MHz
Relative frequency mode (SPCL 20)	Off	Off	Off
<b>AMPLITUDE</b>			
Output amplitude		-140 dBm	-140 dBm
RF output state		On	On
Relative amplitude mode (SPCL 30)	Off	Off	Off
Fixed range amplitude (SPCL 50)	Normal	Normal	Normal
Amplitude display units (SPCL 840)	dBm	dBm	dBm
EMF-Volts amplitude display mode (SPCL 850)	Off	Off	Off
<b>MODULATION</b>			
AM depth		30 %	30 %
FM/ØM deviation		5 kHz	5 kHz
Modulation frequency		1 kHz	1 kHz
Modulation level		0 V	0 V
Pulse width		500 µs	500 µs
Internal AM		Off	Off
External AC AM		Off	Off
External DC AM		Off	Off
Internal FM/ØM		Off	Off
External AC FM/ØM		Off	Off
External DC FM/ØM		Off	Off
External pulse modulation		Off	Off
Modulation Oscillator output (SPCL 40)	On	On	On
Low-rate FM (SPCL 710)	Off	Off	Off
High-rate ØM (SPCL 720)	Off	Off	Off
Low-distortion/fixed range FM (SPCL 730)	Normal	Normal	Normal
Internal pulse modulation (SPCL 740)	Off	Off	Off
Modulation oscillator waveform (SPCL 750)	Sine	Sine	Sine
<b>SWEEP</b>			
Frequency sweep width		100 MHz	100 MHz
Frequency sweep increment		1 MHz	1 MHz
Amplitude sweep width		10 dB	10 dB
Amplitude sweep increment		.1 dB	.1 dB
Active sweep field		Freq.	Freq.
Sweep dwell time (SPCL 890)	0 s	0 s	0 s
Sweep symmetry (SPCL 880)	Sym.	Sym.	Sym.
Sweep mode			Off
<b>EDIT</b>			
Frequency bright-digit		10 MHz	10 MHz
Amplitude bright-digit		10 dBm	10 dBm
AM bright-digit		10 %	10 %
FM bright-digit		1 kHz	1 kHz



Appendix A. Instrument Preset State (cont)

FUNCTION	SET TO STATES																
	SPCL 00	RCL 97 <sup>1</sup>	SPCL 01 <sup>2</sup> (PRESET)														
Modulation frequency bright-digit Modulation level bright-digit Modulation display field Active bright-digit field		1 kHz 100 mV FM Freq.	1 kHz 100 mV FM Freq.														
<b>STEP</b>																	
Frequency step size Amplitude step size AM depth step size FM/øM deviation step size Modulation frequency step size Modulation level step size Active step field		10 MHz 10 dB 10 % 1 kHz 1 kHz .1 V Freq.	10 MHz 10 dB 10 % 1 kHz 1 kHz .1 V Freq.														
<b>MISCELLANEOUS</b>																	
Display (SPCL 770) Key repeat rate (SPCL 860) Knob and step key operation (SPCL 870) Calibration/compensation procedures Amplitude compensation (SPCL 920)			On Medium On, Step Off All														
<b>REMOTE</b>																	
Service request enable (SPCL 13) Event status enable Instrument status change enable			0 0 0														
<p><b>NOTES:</b></p> <p>1. Store and recall operations include these parameters.</p> <p>2. Power-on State.</p> <p>SPCL 00 and RCL 97 are not allowed while the 6080A/AN is sweeping.</p> <p>The following instrument parameters are only set from the Fluke factory or with their associated commands:</p> <table border="0"> <tr> <td>External reference frequency (SPCL 760)</td> <td>Standard</td> </tr> <tr> <td>Memory dividers (SPCL 802)</td> <td>0,0,0,0</td> </tr> <tr> <td>Memory lock state (SPCL 820)</td> <td>Off</td> </tr> <tr> <td>Output compensation data (SPCL 930)</td> <td>Standard</td> </tr> <tr> <td>IEEE-488 address (SPCL 10)</td> <td>2</td> </tr> <tr> <td>IEEE-488 addressed/listen-only/talk-only (SPCL 11)</td> <td>Addressed</td> </tr> <tr> <td>IEEE-488 language (SPCL 12)</td> <td>6080 Language</td> </tr> </table>				External reference frequency (SPCL 760)	Standard	Memory dividers (SPCL 802)	0,0,0,0	Memory lock state (SPCL 820)	Off	Output compensation data (SPCL 930)	Standard	IEEE-488 address (SPCL 10)	2	IEEE-488 addressed/listen-only/talk-only (SPCL 11)	Addressed	IEEE-488 language (SPCL 12)	6080 Language
External reference frequency (SPCL 760)	Standard																
Memory dividers (SPCL 802)	0,0,0,0																
Memory lock state (SPCL 820)	Off																
Output compensation data (SPCL 930)	Standard																
IEEE-488 address (SPCL 10)	2																
IEEE-488 addressed/listen-only/talk-only (SPCL 11)	Addressed																
IEEE-488 language (SPCL 12)	6080 Language																



# Appendix B

## Special Function Table

**SPECIAL FUNCTION TABLE**

**Appendix B. Special Function Table**

SPECIAL FUNCTION	DESCRIPTION
00	Clear special functions
01	Restore Instrument Preset State
02	Initiate power-on self tests
03	Display self test results
08	Display option loading status
09	Display software revision level
10	Display/Set IEEE-488 address
11	Display/Set IEEE-488 address mode
12	Display/Set IEEE-488 language
13	Display/Enter service request mask
14	Set user request SRQ
15	Clear SRQ
20	Disable relative frequency mode
21	Enable relative frequency mode
30	Disable relative amplitude mode
31	Enable relative amplitude mode
40	Enable modulation oscillator output
41	Disable modulation oscillator output
42	Enter modulation frequency with 0.1 Hz resolution
50	Disable fixed range amplitude
51	Enable fixed range amplitude
710	Disable low-rate FM
711	Enable low-rate FM
720	Disable high-rate $\phi$ M
721	Enable high-rate $\phi$ M
730	Select normal range FM
731	Select low-distortion range FM
732	Select fixed range FM
740	Disable internal pulse modulation
741	Enable internal pulse modulation
750	Select Sine oscillator waveform
751	Select triangle oscillator waveform
752	Select square oscillator waveform
753	Select noise oscillator waveform
758	Select pulse waveform
759	Enter pulse width
760	Use 10 MHz external reference input frequency
761	Use alternate external reference input frequency

Appendix B. Special Function Table (cont)

SPECIAL FUNCTION	DESCRIPTION
770	Enable display
771	Disable display
801	Reset memory locations
802	Display/Set memory sequence dividers
810	Unlock memory store operations
811	Lock memory store operations
840	Select dBm amplitude display units
841	Select dBmV amplitude display units
842	Select dBuV amplitude display units
843	Select dBf amplitude display units
850	Disable EMF-Volts amplitude display mode
851	Enable EMF-Volts amplitude display mode
860	Select medium key repeat rate
861	Select fast key repeat rate
862	Select slow key repeat rate
870	Normal knob and step key operation
871	Knob disabled, normal step key operation
872	Normal knob, step keys operate as EDIT up/down
873	Knob disabled, step keys operate as EDIT up/down
880	Select symmetrical sweep symmetry
881	Select asymmetrical sweep symmetry
882	Initiate single sweep
890	Select sweep dwell time of 0 ms
891	Select sweep dwell time of 20 ms
892	Select sweep dwell time of 50 ms
893	Select sweep dwell time of 100 ms
894	Select sweep dwell time of 200 ms
895	Select sweep dwell time of 500 ms

**SPECIAL FUNCTION TABLE**

**Appendix B. Special Function Table (cont)**

SPECIAL FUNCTION	DESCRIPTION
04	Display cal/comp memory checksum status
05	Display cal/comp memory data origins
901	Display test
902	Button test
903	Latch test
904	Initiate self tests with RF output enabled
905	Display operating time since manufacture in hours
907	Repair cal/comp memory checksum errors
909	Diagnostic preset state
920	Enable amplitude compensation
921	Disable all amplitude compensation
922	Disable attenuator amplitude compensation
923	Program alternate A24b attenuator
924	Program alternate A24c attenuator
925	Program alternate A24d attenuator
926	Program alternate A24e attenuator
930	Use normal output compensation data
931	Use alternate output compensation data
941	Set all internal DACs to zero
942	Set all internal DACs to half scale
943	Set all internal DACs to full scale
945	Display sum loop frequency
946	Display coarse loop frequency
947	Display subsynthesizer frequency
961	Transfer output MEC prom data
962	Transfer attenuator MEC prom data
963	Transfer subsynthesizer MEC prom data
971	Automatic coarse loop compensation procedure
972	Automatic sum loop compensation procedure
981	Front panel output compensation procedure
982	Front panel attenuator compensation procedure
983	Front panel output compensation w/default attenuator procedure
984	Front panel subsynthesizer compensation procedure
991	Front panel AM calibration procedure
992	Front panel FM calibration procedure
993	Front panel level calibration procedure
994	Front panel reference oscillator calibration procedure

# **Appendix C**

## **Rejected Entry Error Codes**

**REJECTED ENTRY ERROR CODES**

**Appendix C. Rejected Entry Error Codes**

ERROR CODE	DESCRIPTION
<b>FREQUENCY</b>	
1 2 3 4	Frequency out of range Frequency step size out of range Frequency sweep width out of range Frequency sweep increment out of range
<b>AMPLITUDE</b>	
10 11 12 13 14 15 16 17	Amplitude out of range Amplitude units conversion out of range Amplitude units conversion not allowed with voltage reference Amplitude step size out of range Amplitude step with mixed units not allowed Amplitude step/sweep width/sweep increment units conversion not allowed Amplitude sweep width out of range Amplitude sweep increment out of range
<b>AM</b>	
20 21	AM depth out of range AM step size out of range
<b>FM/øM DEVIATION</b>	
30 31 32 33 34 35	FM/øM deviation out of range FM/øM step size out of range FM/øM units conversion not allowed when external FM enabled FM/øM units conversion out of øM range FM/øM step with mixed units not allowed FM/øM step units conversion not allowed
<b>MOD FREQUENCY / MOD LEVEL</b>	
40 41 42 43 44	Mod frequency out of range Mod frequency step size out of range Mod level out of range Mod level step size out of range Pulse width out of range
<b>SWEEP</b>	
50 51 52 53 54 55	Sweep field (Freq/Ampl) cannot be changed while sweeping Sweep cannot be enabled with current sweep parameters Entry conflicts with active sweep Selected function not allowed while sweep is active Amplitude sweep with mixed units not allowed Selected function not allowed unless sweep is active



## Appendix C. Rejected Entry Error Codes (cont)

ERROR CODE	DESCRIPTION
<b>SPECIAL FUNCTION AND MEMORY</b>	
60 61 62 63	Special function code invalid Memory location number invalid Memory location data invalid Store operation not allowed when memory locked
<b>REMOTE</b>	
70 71 72 73 74 75 76 77 78 79 80 81 82 83	IEEE address must be $\leq 30$ IEEE invalid edit or step IEEE invalid command IEEE bad command syntax IEEE bad argument value IEEE bad argument type IEEE bad argument count IEEE invalid keyword IEEE 488.2 unterminated command IEEE 488.2 interrupted query IEEE 488.2 I/O deadlock IEEE error/status queue overflow IEEE recursive trigger buffer not allowed IEEE command not allowed in local mode
<b>CALIBRATION/COMPENSATION</b>	
90 91 92 93 94 95 96 97 98 99 100	CAL COMP switch not set to 1 (on) Cal/comp adjustment out of range Cal/comp procedure incomplete, data cannot be stored Cal/comp data range error (too much correction) Command not allowed during current cal/comp procedure Command only allowed with appropriate cal/comp procedure Internal cal/comp data transfer error Stored cal/comp memory contains invalid data MEC PROM ID code invalid, or MEC PROM checksum error Sum loop compensation procedure failed Coarse loop compensation procedure failed



# Appendix D

## Overrange/Uncal Status Codes

Appendix D. Overage/Uncal Status Codes

STATUS CODE	DESCRIPTION
<b>UNSPECIFIED OPERATION</b>	
201 202	Level correction disabled High-stability reference over cold
<b>HARDWARE LIMITED</b>	
220* 221* 222* 223* 224* 225* 226*	Level DAC at 0(Amplitude fixed range) Level DAC at max(Amplitude fixed range) FM DAC at 0 (FM fixed range) FM DAC at max (FM fixed range) FM out of range for RF frequency band Mod frequency too low for pulse mode Pulse width $\geq 1/\text{mod frequency}$
<b>HARDWARE FAULT</b>	
240* 241* 242* 243* 244* 245* 246* 247* 248* 249* 250*	RPP tripped ALC loop unlevelled or AM overmodulation Sub synthesizer unlocked Coarse loop unlocked Sum loop unlocked Sum loop unlevelled Reference unlocked FM loop unlocked or FM overmodulation DCFM DAC at 0 DCFM DAC at max Multiple calibration/compensation memory errors
<b>NOTE:</b>	
Flashing codes (denoted by *) indicate abnormal operation or aberrated output. Non-flashing codes indicate operation outside specified range.	



# Appendix E

## Self-Test Status Codes

**Appendix E. Self-Test Status Codes**

STATUS CODE	DESCRIPTION
00	No self test errors
301	Self tests aborted
302	Calibration/compensation memory checksum test failed
303	Ram test failed
304	EPROM test failed
305	Non-volatile memory test failed
306	IEEE interface test failed
307-309	AM tests (See Service Manual)
310-317	FM tests (See Service Manual)
318-319	DCFM tests (See Service Manual)
320-323	Coarse loop tests (See Service Manual)
324-326	Subsynthesizer tests (See Service Manual)
327-333	Sum loop tests (See Service Manual)
334-336	RF output tests (See Service Manual)
337-338	Pulse modulator tests (See Service Manual)
339-356	Filter tests (See Service Manual)



## Appendix F Rear Panel AUX Connector Pinout

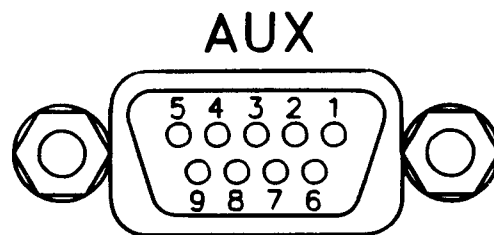

1	Input	Sequence down memory location
2	Input	Sequence up memory location
3		Ground
4	Output	Pen Lift/Blanking
5	Output	Sweep DAC
6		--
7		--
8		--
9	Input	Toggle bright digit between frequency and amplitude fields

